

International IOR Rectifier

QUIETIR Series 40EPF.. HV

FAST SOFT RECOVERY RECTIFIER DIODE

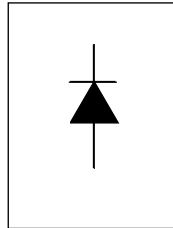

$V_F < 1.25V @ 20A$
 $t_{rr} = 95 \text{ ns}$
 $V_{RRM} 1000 \text{ to } 1200V$

The 40EPF.. fast soft recovery *QUIETIR* rectifier series has been optimized for combined short reverse recovery time and low forward voltage drop.

The glass passivation ensures stable reliable operation in the most severe temperature and power cycling conditions.

Typical applications are both:

- output rectification and freewheeling in inverters, choppers and converters
- and input rectifications where severe restrictions on conducted EMI should be met.

Major Ratings and Characteristics

Parameter/Features	40EPF..	Units
$I_{F(AV)}$ Sinusoidal waveform	40	A
V_{RRM}	1000 to 1200	V
I_{FSM}	475	A
$V_F @ 20A, T_J = 25^\circ C$	1.25	V
$t_{rr} @ 1A, -100A/\mu s$	95	ns
T_J	-40 to 150	$^\circ C$

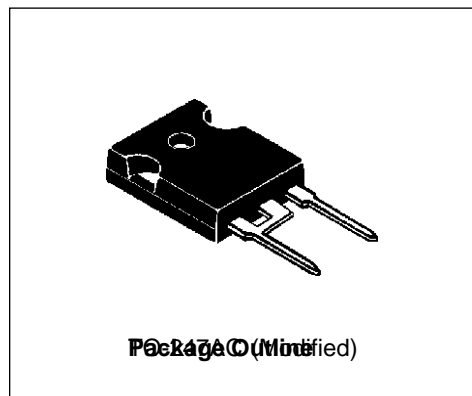

Voltage Ratings

Part Number	V_{RRM} , maximum peak reverse voltage V	V_{RSM} , maximum non repetitive peak reverse voltage V	I_{RRM} 150°C mA
40EPF10	1000	1100	10
40EPF12	1200	1300	

Absolute Maximum Ratings

Parameters	40EPF..	Units	Conditions
$I_{F(AV)}$ Max. Average Forward Current	40	A	@ $T_C = 105^\circ\text{C}$, 180° conduction half sine wave
I_{FSM} Max. Peak One Cycle Non-Repetitive Surge Current	400	A	10ms Sine pulse, rated V_{RRM} applied
	475		10ms Sine pulse, no voltage reapplied
I^2t Max. I^2t for fusing	800	s^2	10ms Sine pulse, rated V_{RRM} applied
	1131		10ms Sine pulse, no voltage reapplied
$I^2\sqrt{t}$ Max. $I^2\sqrt{t}$ for fusing	11310	$\text{A}^2\sqrt{\text{s}}$	$t = 0.1$ to 10ms, no voltage reapplied

Electrical Specifications

Parameters	40EPF..	Units	Conditions
V_{FM} Max. Forward Voltage Drop	1.4	V	@ 40A, $T_J = 25^\circ\text{C}$
r_t Forward slope resistance	6.82	$\text{m}\Omega$	$T_J = 125^\circ\text{C}$
$V_{F(TO)}$ Threshold voltage	0.94	V	
I_{RM} Max. Reverse Leakage Current	0.1	mA	$T_J = 25^\circ\text{C}$
	10		$T_J = 150^\circ\text{C}$

$V_R = \text{rated } V_{RRM}$

Recovery Characteristics

Parameters	40EPF..	Units	Conditions
t_{rr} Reverse Recovery Time	450	ns	$I_F @ 10\text{Apk}$ @ 25A/ μs @ 25°C
I_{rr} Reverse Recovery Current	6	A	
Q_{rr} Reverse Recovery Charge	1.8	μC	
S Typical Snap Factor	0.5		

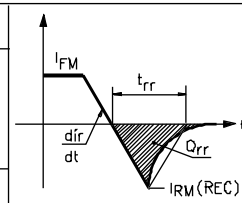

Thermal-Mechanical Specifications

Parameters	40EPF..	Units	Conditions
T _J Max. Junction Temperature Range	-40 to 150	°C	
T _{stg} Max. Storage Temperature Range	-40 to 150	°C	
R _{thJC} Max. Thermal Resistance Junction to Case	0.6	°C/W	DC operation
R _{thJA} Max. Thermal Resistance Junction to Ambient	40	°C/W	
R _{thCS} Typical Thermal Resistance, Case to Heatsink	0.2	°C/W	Mounting surface , smooth and greased
wt Approximate Weight	6 (0.21)	g (oz.)	
T Mounting Torque	Min.	6 (5)	Kg-cm (lbf-in)
	Max.	12 (10)	
Case Style	TO-247AC		JEDEC (Modified)

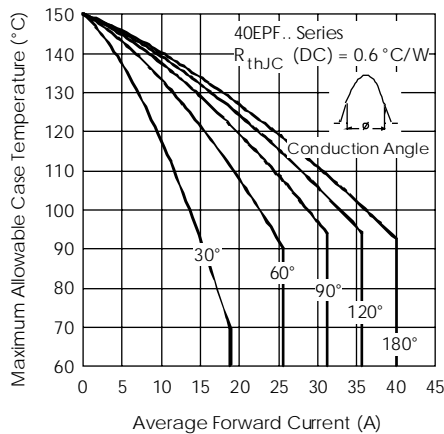

Fig. 1 - Current Rating Characteristics

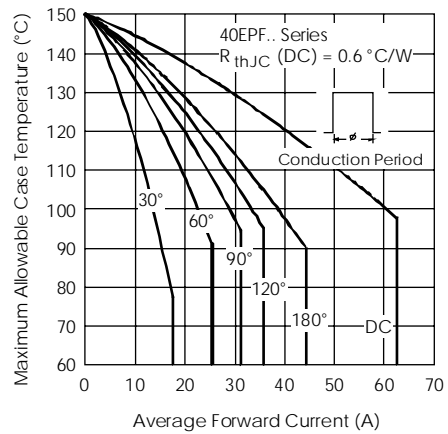

Fig. 2 - Current Rating Characteristics

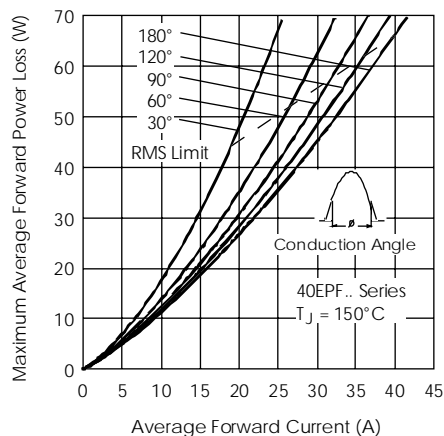

Fig. 3 - Forward Power Loss Characteristics

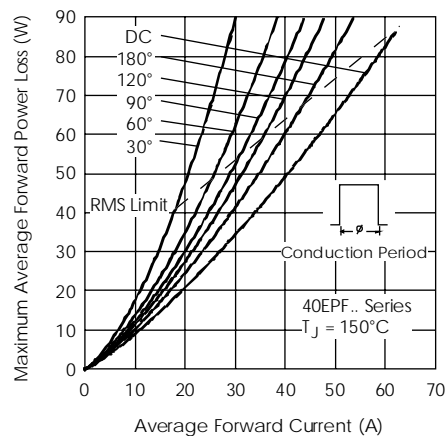

Fig. 4 - Forward Power Loss Characteristics

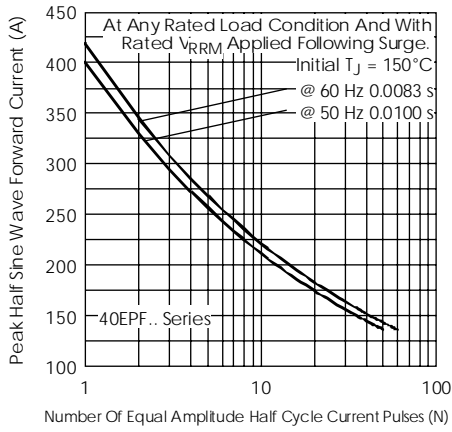

Fig.5- Maximum Non-Repetitive Surge Current

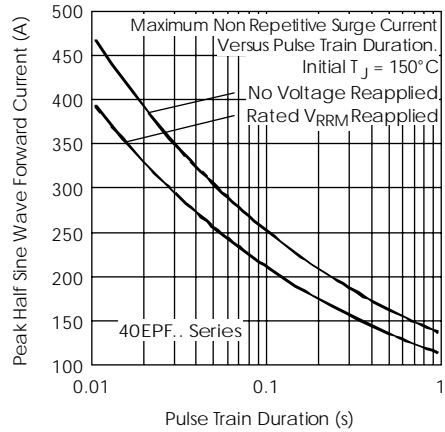

Fig.6- Maximum Non-Repetitive Surge Current

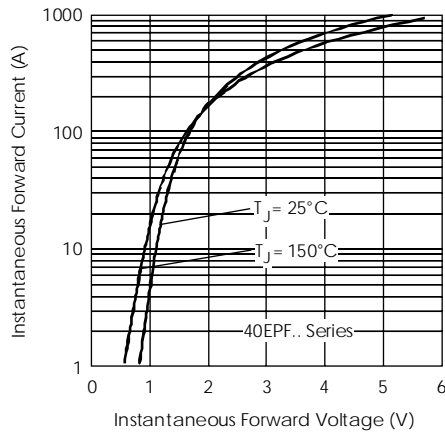

Fig.7- Forward Voltage Drop Characteristics

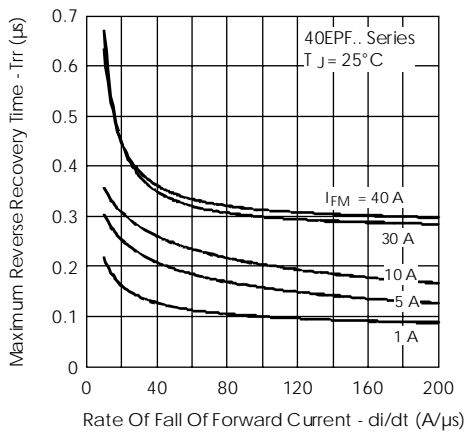

Fig.8- Recovery Time Characteristics, $T_J = 25^\circ\text{C}$

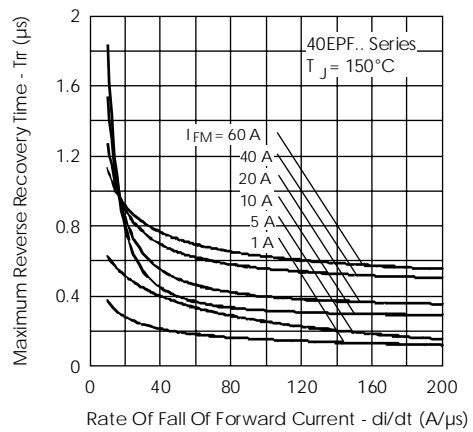

Fig.9- Recovery Time Characteristics, $T_J = 150^\circ\text{C}$

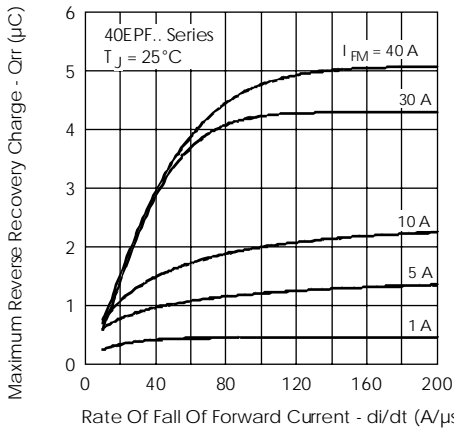

Fig. 10 - Recovery Charge Characteristics, $T_J = 25^\circ\text{C}$

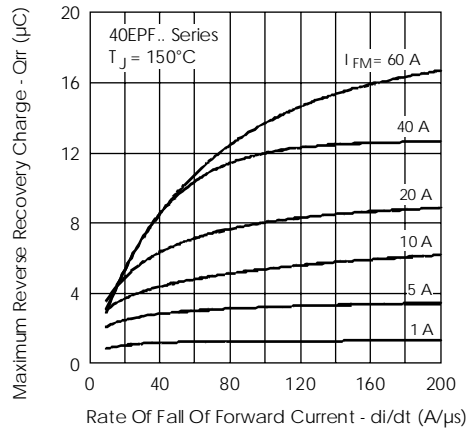

Fig. 11 - Recovery Charge Characteristics, $T_J = 150^\circ\text{C}$

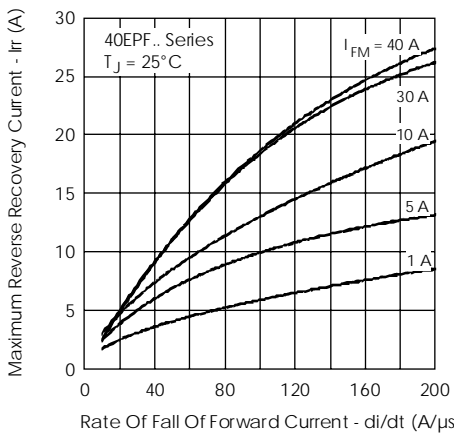

Fig. 12 - Recovery Current Characteristics, $T_J = 25^\circ\text{C}$

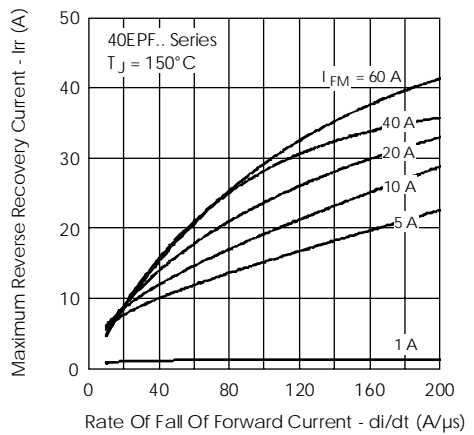

Fig. 13 - Recovery Current Characteristics, $T_J = 150^\circ\text{C}$

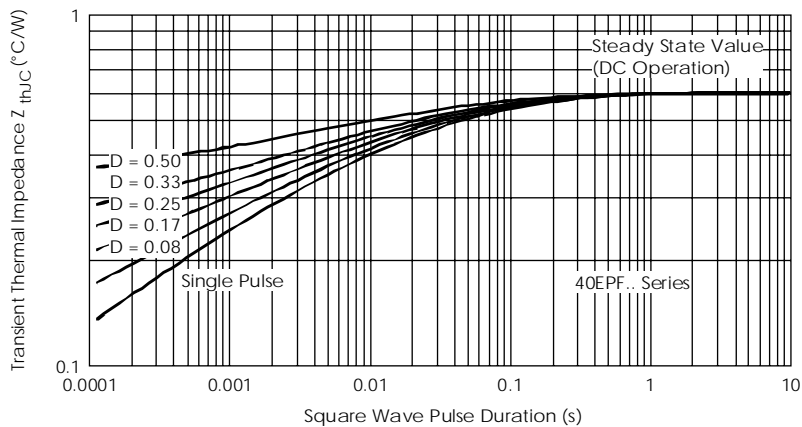
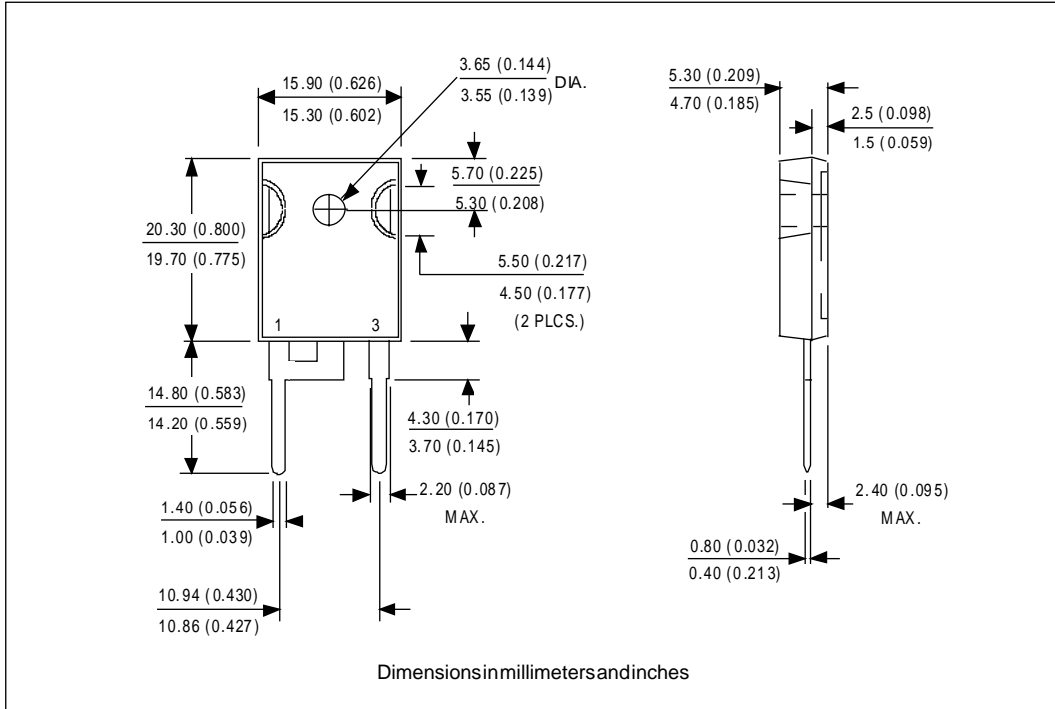
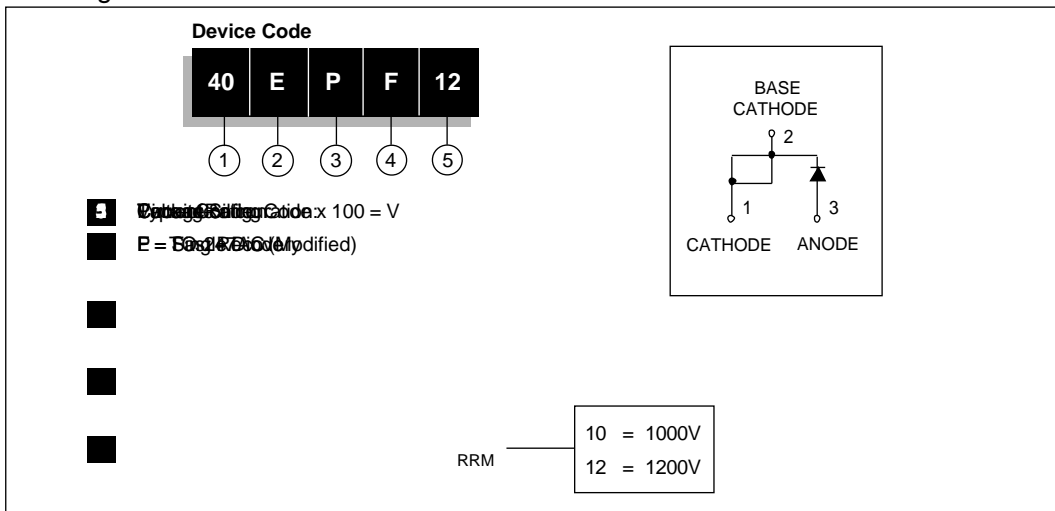

Fig. 14 - Thermal Impedance Z_{thJC} Characteristics

Outline Table



Ordering Information Table





Notice

The products described herein were acquired by Vishay Intertechnology, Inc., as part of its acquisition of International Rectifier's Power Control Systems (PCS) business, which closed in April 2007. Specifications of the products displayed herein are pending review by Vishay and are subject to the terms and conditions shown below.

Specifications of the products displayed herein are subject to change without notice. Vishay Intertechnology, Inc., or anyone on its behalf, assumes no responsibility or liability for any errors or inaccuracies.

Information contained herein is intended to provide a product description only. No license, express or implied, by estoppel or otherwise, to any intellectual property rights is granted by this document. Except as provided in Vishay's terms and conditions of sale for such products, Vishay assumes no liability whatsoever, and disclaims any express or implied warranty, relating to sale and/or use of Vishay products including liability or warranties relating to fitness for a particular purpose, merchantability, or infringement of any patent, copyright, or other intellectual property right.

The products shown herein are not designed for use in medical, life-saving, or life-sustaining applications. Customers using or selling these products for use in such applications do so at their own risk and agree to fully indemnify Vishay for any damages resulting from such improper use or sale.

International Rectifier®, IR®, the IR logo, HEXFET®, HEXSense®, HEXDIP®, DOL®, INTERO®, and POWIRTRAIN® are registered trademarks of International Rectifier Corporation in the U.S. and other countries. All other product names noted herein may be trademarks of their respective owners.