

14-stage ripple carry binary counter/divider and oscillator

Datasheet - production data

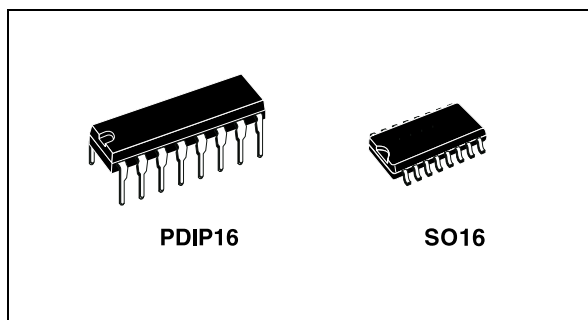

Applications

- Automotive
- Industrial
- Computer
- Consumer

Description

The HCF4060 device is a monolithic integrated circuit fabricated in MOS (metal oxide semiconductor) technology available in SO16 and PDIP16 packages.

The HCF4060 device consists of an oscillator section and 14 ripple carry binary counter stages.

The oscillator configuration allows design of either RC or crystal oscillator circuits. A RESET input is provided which resets the counter to the all 0's state and disables the oscillator. A high level on the RESET line accomplishes the reset function. All counter stages are master slave flip-flops. The state of the counter is advanced one step in binary order on the negative transition of ϕ_1 (and ϕ_0). All inputs and outputs are fully buffered. Schmitt trigger action on the clock pin permits unlimited clock rise and fall time.

Features

- Medium speed operation
- Common reset
- Fully static operation
- Buffered inputs and outputs
- Quiescent current specified up to 20 V
- 5 V, 10 V and 15 V parametric ratings
- Input leakage current: $I_l = 100 \text{ nA}$ (max.) at $V_{DD} = 18 \text{ V}$, $T_A = 25 \text{ }^\circ\text{C}$
- 100% tested for quiescent current
- ESD performance
 - HBM: 1 kV
 - MM: 200 V
 - CDM: 1 kV

Table 1. Device summary

Order code	Temperature range	Package	Packaging	Marking
HCF4060M013TR	-55/+125 °C	SO16	Tape and reel	HCF4060
HCF4060YM013TR ⁽¹⁾	-40/+125 °C	SO16 (automotive version)	Tape and reel	HCF4060Y
HCF4060BEY	-55/+125 °C	PDIP16	Tube	HCF4066BE

1. Qualification and characterization according to AEC Q100 and Q003 or equivalent, advanced screening according to AEC Q001 and Q002 or equivalent.

Contents

1	Pin information	3
2	Functional description	4
3	Electrical characteristics	6
4	Package information	11
	4.1 PDIP16 (0.25) package information	12
	4.2 SO16 package information	13
5	Ordering information	14
6	Revision history	14

1 Pin information

Figure 1. Pin connection

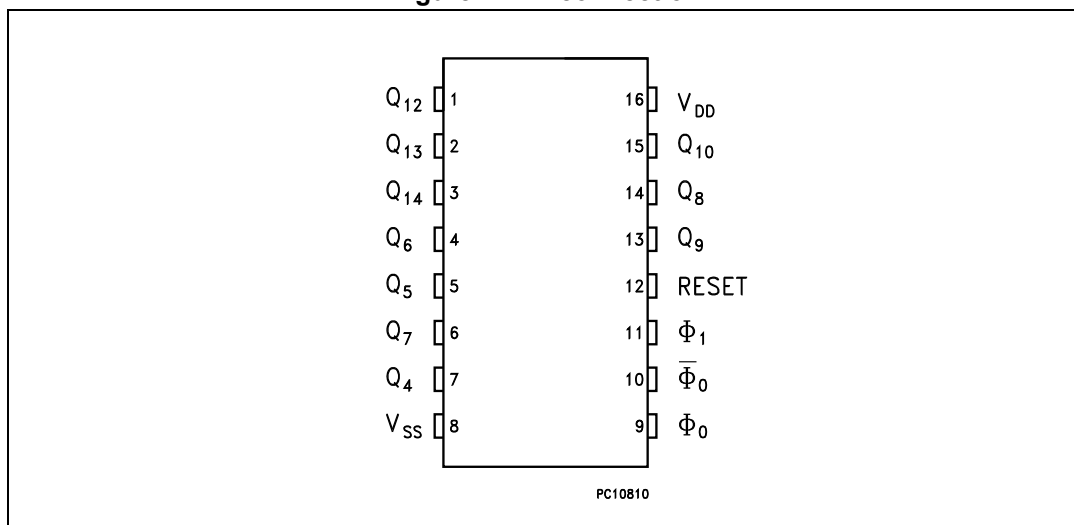

Table 2. Pin description

Pin no.	Symbol	Name and function
1, 2, 3, 4, 5, 6, 7, 13, 14, 15	$Q_{12}, Q_{13}, Q_{14}, Q_6, Q_5, Q_7, Q_4, Q_9, Q_8, Q_{10}$	Outputs
9, 10, 11	$\Phi_0, \bar{\Phi}_0, \Phi_1$	Oscillator input
12	RESET	Reset
8	V_{SS}	Negative supply voltage
16	V_{DD}	Positive supply voltage

2 Functional description

Figure 2. Logic diagram

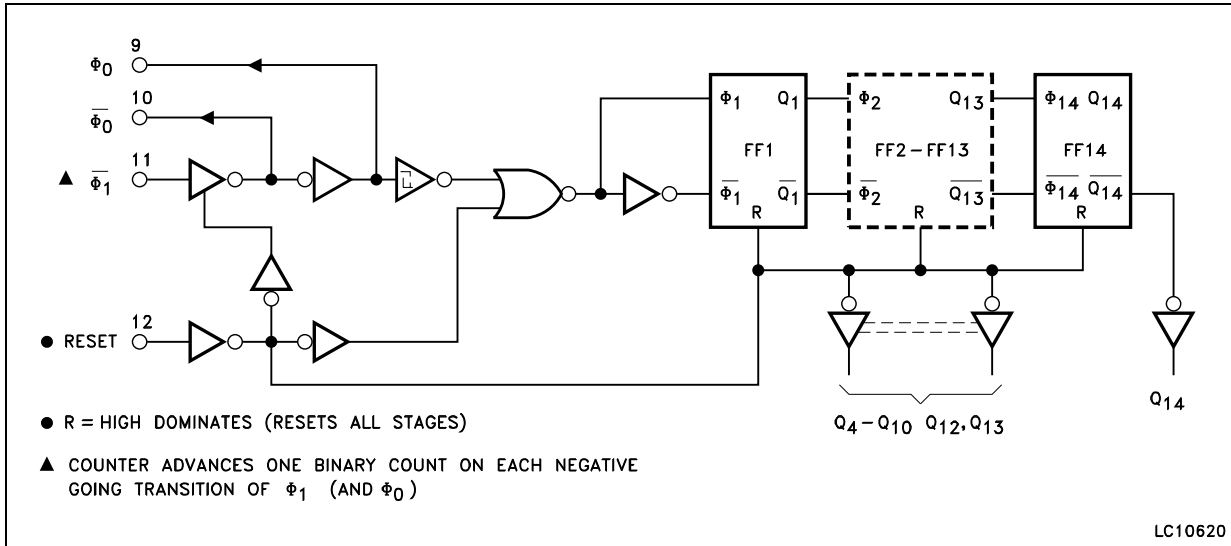

Figure 3. Functional diagram

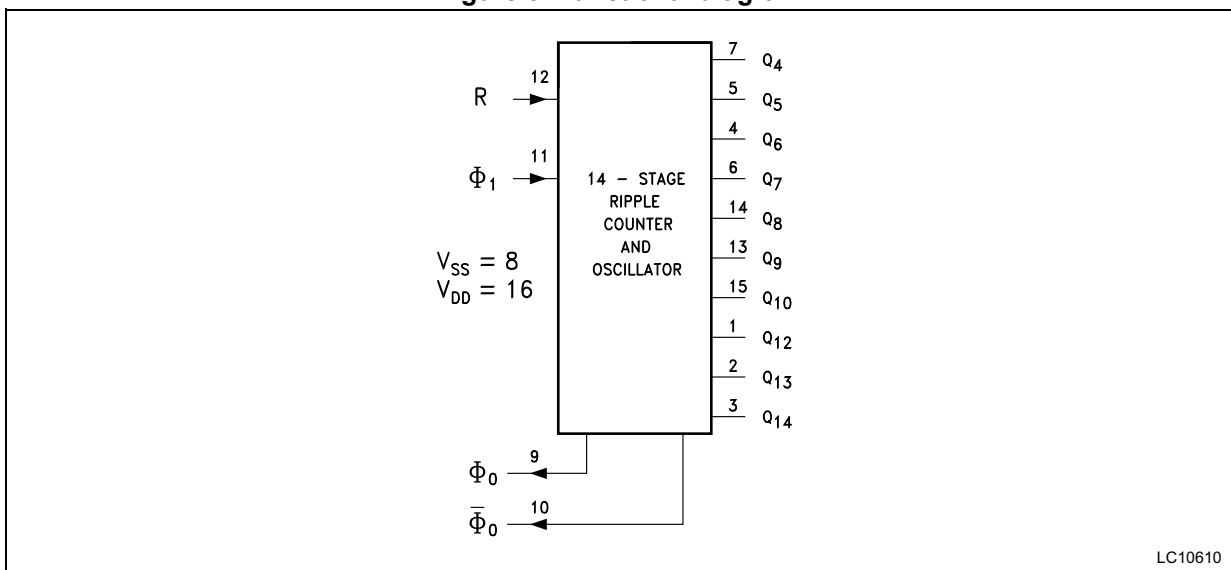
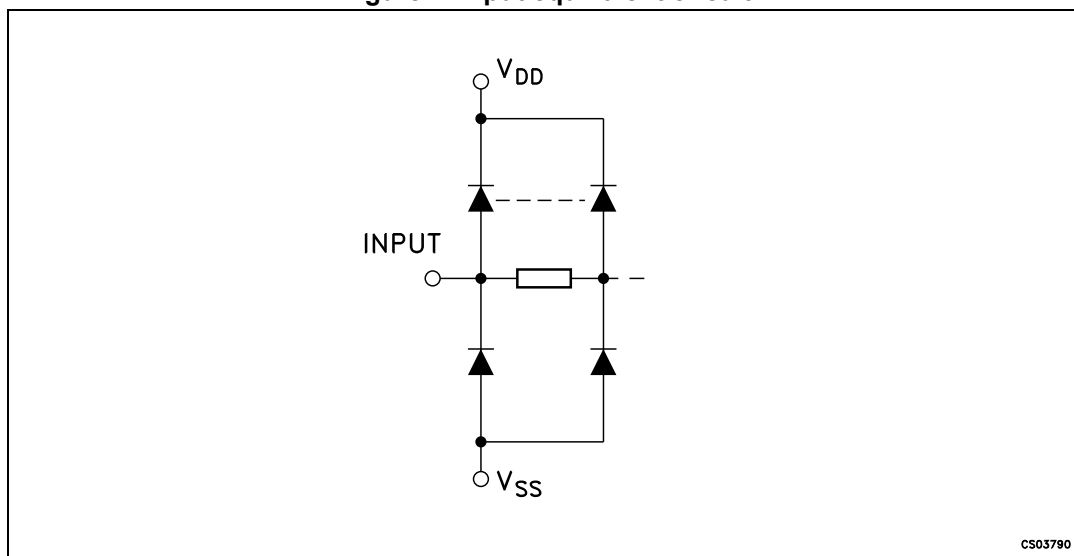

Figure 4. Input equivalent circuit



3 Electrical characteristics

Absolute maximum ratings are those values beyond which damage to the device may occur. Functional operation under these conditions is not implied. All voltage values are referred to V_{SS} pin voltage.

Table 3. Absolute maximum ratings

Symbol	Parameter	Value	Unit
V_{DD}	Supply voltage	-0.5 to +22	V
V_I	DC input voltage	-0.5 to $V_{DD} + 0.5$	
I_I	DC input current	± 10	mA
P_D	Power dissipation per package	200	mW
	Power dissipation per output transistor	100	
T_{op}	Operating temperature	-55 to +125	°C
T_{stg}	Storage temperature	-65 to +150	

Table 4. Recommended operating conditions

Symbol	Parameter	Value	Unit
V_{DD}	Supply voltage	3 to 20	V
V_I	Input voltage	0 to V_{DD}	
T_{op}	Operating temperature	-55 to 125	°C

Table 5. DC specifications⁽¹⁾

Symbol	Parameter	Test condition				Value						Unit	
		V _I (V)	V _O (V)	I _O (μ A)	V _{DD} (V)	T _A = 25 °C			-40 to 85 °C		-55 to 125 °C		
						Min.	Typ.	Max.	Min.	Max.	Min.		Max.
I _L	Quiescent current	0/5			5		0.04	5		5		150	μ A
		0/10			10		0.04	10		10		300	
		0/15			15		0.04	20		20		600	
		0/20			20		0.08	100		100		3000	
V _{OH}	High level output voltage	0/5		<1	5	4.95			4.95		4.95		V
		0/10		<1	10	9.95			9.95		9.95		
		0/15		<1	15	14.95			14.95		14.95		
V _{OL}	Low level output voltage	5/0		<1	5		0.05			0.05		0.05	V
		10/0		<1	10		0.05			0.05		0.05	
		15/0		<1	15		0.05			0.05		0.05	
V _{IH}	High level input voltage		0.5/4.5	<1	5	3.5			3.5		3.5		V
			1/9	<1	10	7			7		7		
			1.5/13.5	<1	15	11			11		11		
V _{IL}	Low level input voltage		4.5/0.5	<1	5			1.5		1.5		1.5	V
			9/1	<1	10			3		3		3	
			13.5/1.5	<1	15			4		4		4	
I _{OH}	Output drive current	0/5	2.5	<1	5	-1.36	-3.2		-1.15		-1.1		mA
		0/5	4.6	<1	5	-0.44	-1		-0.36		-0.36		
		0/10	9.5	<1	10	-1.1	-2.6		-0.9		-0.9		
		0/15	13.5	<1	15	-3.0	-6.8		-2.4		-2.4		
I _{OL}	Output sink current	0/5	0.4	<1	5	0.44	1		0.36		0.36		mA
		0/10	0.5	<1	10	1.1	2.6		0.9		0.9		
		0/15	1.5	<1	15	3.0	6.8		2.4		2.4		
I _I	Input leakage current	0/18	Any input		18		$\pm 10^{-5}$	± 0.3		± 0.3		± 1	μ A
C _I	Input capacitance		Any input				5	7.5					pF

1. The noise margin for both "1" and "0" level is: 1 V min. with V_{DD} = 5 V, 2 V min. with V_{DD} = 10 V, 2.5 V min. with V_{DD} = 15 V.

Table 6. Dynamic electrical characteristics
 (T_{amb} = 25 °C, C_L = 50 pF, R_L = 200 KΩ, t_r = t_f = 20 ns)

Symbol	Parameter	Test condition		Value ⁽¹⁾			Unit
		V _{DD} (V)		Min.	Typ.	Max.	
t _{TLH} , t _{THL}	Output transition time	5			100	200	ns
		10			50	100	
		15			40	80	
t _{PLH} , t _{PHL}	Propagation delay time (φ to Q ₄ out)	5			370	740	
		10			150	300	
		15			100	200	
t _{PLH} , t _{PHL}	Propagation delay time (Q _n to Q _{n+1})	5			100	200	
		10			50	100	
		15			40	80	
t _w	Input pulse width	5	f = 100 KHz		50	100	
		10			20	40	
		15			15	30	
t _r , t _f	Input pulse rise and fall time	5		Unlimited			μs
		10					
		15					
f _{max}	Maximum clock input frequency	5		3.5	7		MHz
		10		8	16		
		15		12	24		
Reset operation							
t _{PHL}	Propagation delay time	5			180	360	ns
		10			80	160	
		15			50	100	
t _w	Input pulse width	5			60	120	
		10			30	60	
		15			20	40	
RC operation							
	Variation of frequency (unit-to-unit)	5	C _x = 200 pF, R _s = 560 KΩ, R _x = 50 KΩ	18	21.5	25	KHz
		10		20	23	26	
		15		21.1	24	27	
	Variation of frequency with voltage change (the same unit)	5 to 10	C _x = 200 pF, R _s = 560 KΩ, R _x = 50 KΩ			2	
		10 to 15				1	

Table 6. Dynamic electrical characteristics
 ($T_{amb} = 25\text{ °C}$, $C_L = 50\text{ pF}$, $R_L = 200\text{ K}\Omega$, $t_r = t_f = 20\text{ ns}$) (continued)

Symbol	Parameter	Test condition		Value ⁽¹⁾			Unit
		V _{DD} (V)		Min.	Typ.	Max.	
R _x		5	C _x = 10 μ F			20	M Ω
		10	C _x = 50 μ F			20	
		15	C _x = 10 μ F			10	
C _x		5	R _x = 500 K Ω			1000	μ F
		10	R _x = 300 K Ω			50	
		15	R _x = 300 K Ω			50	
	Maximum oscillator frequency ⁽²⁾	10	R _x = 5 K Ω , C _x = 15 pF	530	650	810	pF
15		690		800	940		

1. Typical temperature coefficient for all V_{DD} values is 0.3 %/°C, all input rise and fall times = 20 ns.
2. RC oscillator applications are not recommended at supply voltages below 7 V for R_x = 50 K Ω .

Figure 5. Detail of typical flip-flop stage

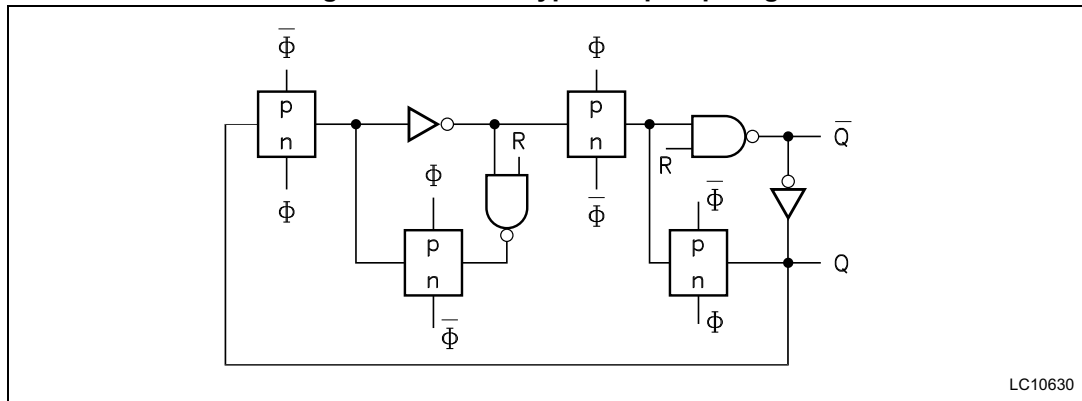

Figure 6. Typical RC oscillator circuit

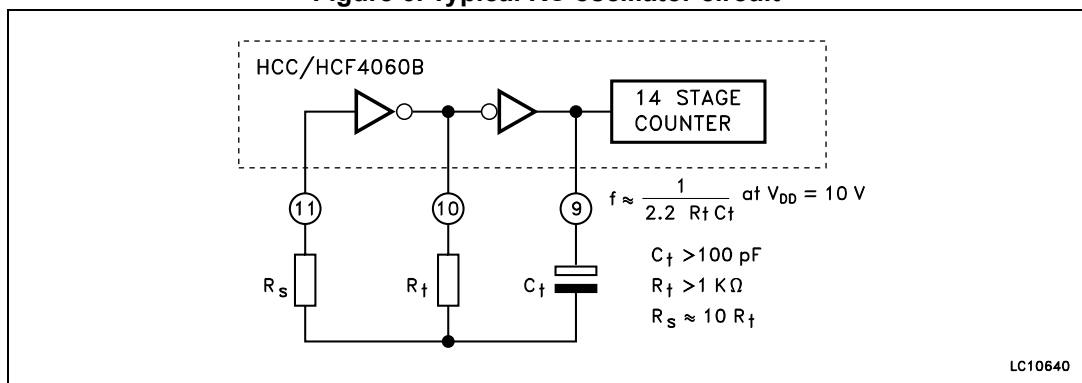
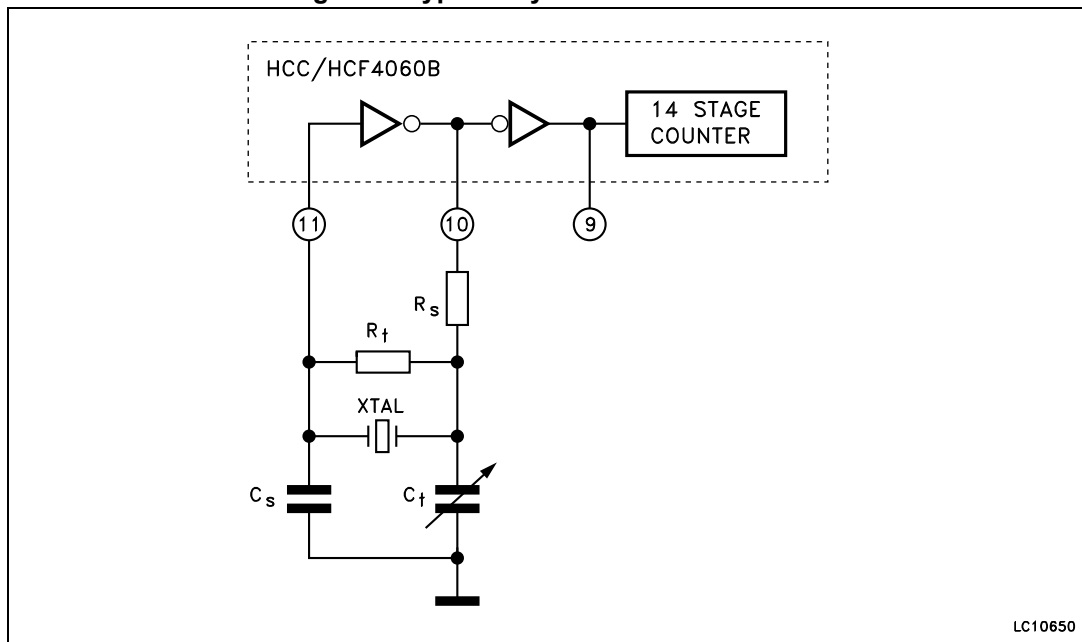

Figure 7. Typical crystal oscillator circuit



4 Package information

In order to meet environmental requirements, ST offers these devices in different grades of ECOPACK[®] packages, depending on their level of environmental compliance. ECOPACK specifications, grade definitions and product status are available at: www.st.com. ECOPACK is an ST trademark.

4.1 PDIP16 (0.25) package information

Figure 8. PDIP16 (0.25) package mechanical drawing

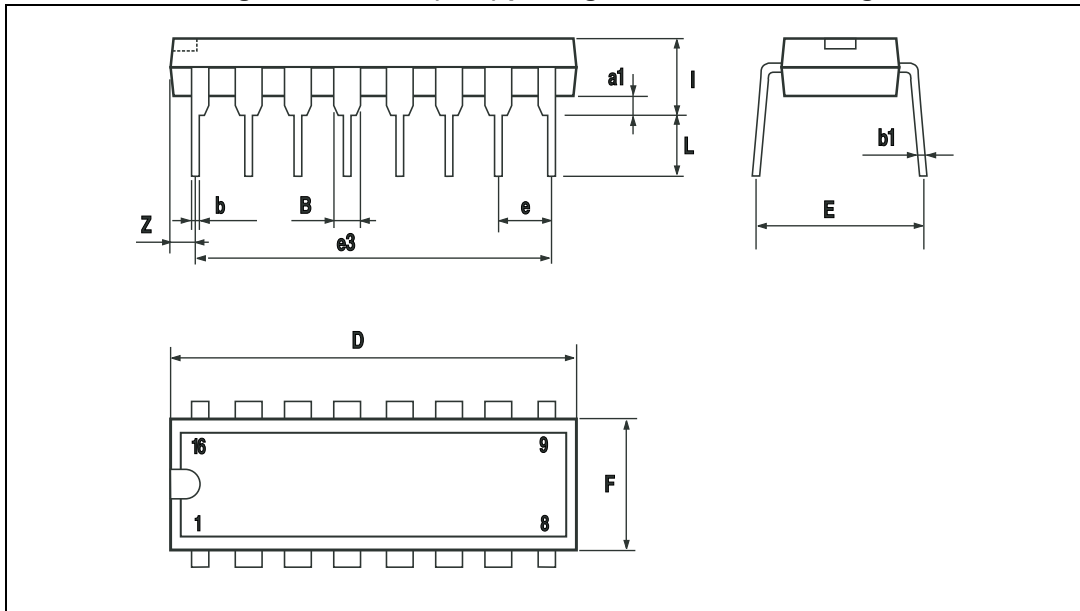
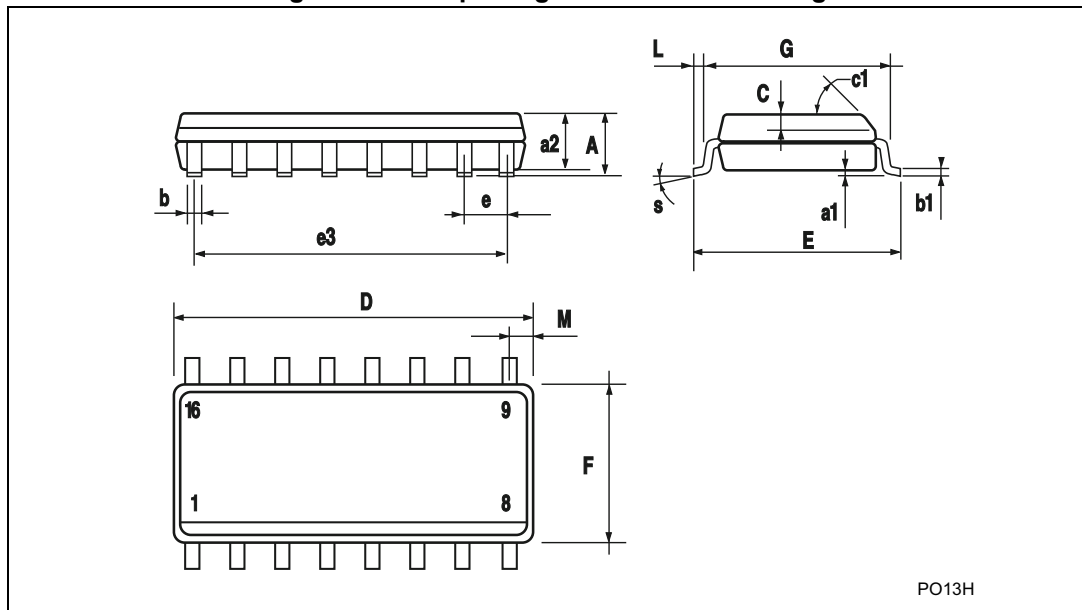

Table 7. PDIP16 (0.25) package mechanical data

Symbol	Dimensions					
	mm			inch		
	Min.	Typ.	Max.	Min.	Typ.	Max.
a1	0.51			0.020		
B	0.77		1.65	0.030		0.065
b		0.5			0.020	
b1		0.25			0.010	
D			20			0.787
E		8.5			0.335	
e		2.54			0.100	
e3		17.78			0.700	
F			7.1			0.280
I			5.1			0.201
L		3.3			0.130	
Z			1.27			0.050

4.2 SO16 package information

Figure 9. SO16 package mechanical drawing



PO13H

Table 8. SO16 package mechanical data

Symbol	Dimensions					
	mm			inch		
	Min.	Typ.	Max.	Min.	Typ.	Max.
A			1.75			0.068
a1	0.1		0.2	0.004		0.008
a2			1.65			0.064
b	0.35		0.46	0.013		0.018
b1	0.19		0.25	0.007		0.010
C		0.5			0.019	
c1	45° (typ.)					
D	9.8		10	0.385		0.393
E	5.8		6.2	0.228		0.244
e		1.27			0.050	
e3		8.89			0.350	
F	3.8		4.0	0.149		0.157
G	4.6		5.3	0.181		0.208
L	0.5		1.27	0.019		0.050
M			0.62			0.024
S	8° (max.)					

5 Ordering information

Table 9. Order codes

Order code	Temperature range	Package	Packaging	Marking
HCF4060M013TR	-55/+125 °C	SO16	Tape and reel	HCF4060
HCF4060YM013TR ⁽¹⁾	-40/+125 °C	SO16 (automotive version)		HCF4060Y
HCF4060BEY	-55/+125 °C	PDIP16	Tube	HCF4066BE

1. Qualification and characterization according to AEC Q100 and Q003 or equivalent, advanced screening according to AEC Q001 and Q002 or equivalent.

6 Revision history

Table 10. Document revision history

Date	Revision	Changes
29-Oct-2012	5	Updated Features (added ESD values), added Applications . Updated Table 1 (reformatted table, added order codes, temperature range, marking, updated package and packaging, added note 1.). Moved Description to page 2, updated Description (unified part numbers and package names). Updated Section 2 to Section 4 (added titles and numbering). Reformatted Section 4 (added ECOPACK text, Figure 8 , Figure 9 , Table 7 and Table 8 , unified package names). Minor corrections throughout document.
02-May-2013	6	Updated Features (ESD values) Added Ordering information

Please Read Carefully:

Information in this document is provided solely in connection with ST products. STMicroelectronics NV and its subsidiaries ("ST") reserve the right to make changes, corrections, modifications or improvements, to this document, and the products and services described herein at any time, without notice.

All ST products are sold pursuant to ST's terms and conditions of sale.

Purchasers are solely responsible for the choice, selection and use of the ST products and services described herein, and ST assumes no liability whatsoever relating to the choice, selection or use of the ST products and services described herein.

No license, express or implied, by estoppel or otherwise, to any intellectual property rights is granted under this document. If any part of this document refers to any third party products or services it shall not be deemed a license grant by ST for the use of such third party products or services, or any intellectual property contained therein or considered as a warranty covering the use in any manner whatsoever of such third party products or services or any intellectual property contained therein.

UNLESS OTHERWISE SET FORTH IN ST'S TERMS AND CONDITIONS OF SALE ST DISCLAIMS ANY EXPRESS OR IMPLIED WARRANTY WITH RESPECT TO THE USE AND/OR SALE OF ST PRODUCTS INCLUDING WITHOUT LIMITATION IMPLIED WARRANTIES OF MERCHANTABILITY, FITNESS FOR A PARTICULAR PURPOSE (AND THEIR EQUIVALENTS UNDER THE LAWS OF ANY JURISDICTION), OR INFRINGEMENT OF ANY PATENT, COPYRIGHT OR OTHER INTELLECTUAL PROPERTY RIGHT.

ST PRODUCTS ARE NOT AUTHORIZED FOR USE IN WEAPONS. NOR ARE ST PRODUCTS DESIGNED OR AUTHORIZED FOR USE IN: (A) SAFETY CRITICAL APPLICATIONS SUCH AS LIFE SUPPORTING, ACTIVE IMPLANTED DEVICES OR SYSTEMS WITH PRODUCT FUNCTIONAL SAFETY REQUIREMENTS; (B) AERONAUTIC APPLICATIONS; (C) AUTOMOTIVE APPLICATIONS OR ENVIRONMENTS, AND/OR (D) AEROSPACE APPLICATIONS OR ENVIRONMENTS. WHERE ST PRODUCTS ARE NOT DESIGNED FOR SUCH USE, THE PURCHASER SHALL USE PRODUCTS AT PURCHASER'S SOLE RISK, EVEN IF ST HAS BEEN INFORMED IN WRITING OF SUCH USAGE, UNLESS A PRODUCT IS EXPRESSLY DESIGNATED BY ST AS BEING INTENDED FOR "AUTOMOTIVE, AUTOMOTIVE SAFETY OR MEDICAL" INDUSTRY DOMAINS ACCORDING TO ST PRODUCT DESIGN SPECIFICATIONS. PRODUCTS FORMALLY ESCC, QML OR JAN QUALIFIED ARE DEEMED SUITABLE FOR USE IN AEROSPACE BY THE CORRESPONDING GOVERNMENTAL AGENCY.

Resale of ST products with provisions different from the statements and/or technical features set forth in this document shall immediately void any warranty granted by ST for the ST product or service described herein and shall not create or extend in any manner whatsoever, any liability of ST.

ST and the ST logo are trademarks or registered trademarks of ST in various countries.

Information in this document supersedes and replaces all information previously supplied.

The ST logo is a registered trademark of STMicroelectronics. All other names are the property of their respective owners.

© 2013 STMicroelectronics - All rights reserved

STMicroelectronics group of companies

Australia - Belgium - Brazil - Canada - China - Czech Republic - Finland - France - Germany - Hong Kong - India - Israel - Italy - Japan - Malaysia - Malta - Morocco - Philippines - Singapore - Spain - Sweden - Switzerland - United Kingdom - United States of America

www.st.com

