

Kunde / customer :

Artikelnummer / part number : **82531400**

Datum / Date : **15.06.07**

Bezeichnung :

description : **1206 SMD VARISTOR**

Lead Free

SMD size:

**1206**

ROHS Compliant

**A Mechanische Abmessungen / dimensions :**

SIZE

(Unit : mm)

SIZE	W	L	T	a
402	0.5	1.0	0.6	0.25
603	0.8	1.6	0.9	0.3
805	1.25	2.0	1.2	0.3
1206	1.6	3.2	1.5	0.5
1210	2.5	3.2	1.5	0.5
1812	3.2	4.5	2.0	0.5
2220	5.0	5.7	2.5	0.5

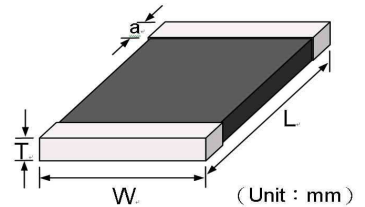

**B Elektrische Eigenschaften / electrical properties :**

TECHNICAL DATA

Part Number	Working Voltage		Clamping Voltage	Peak Current	Energy	Breakdown Voltage	Capacitance
	AC	DC					
<b>82531400</b>	<b>40</b>	<b>56</b>	<b>120</b>	<b>200</b>	<b>1.0</b>	<b>70</b>	<b>180</b>

- \* 1 The varistor voltage was measured at 1 mA current , tolerance at 12~18V(+/-15%), exceed 22V (+/-10%) Or tolerance to specify at : +/-10%
- \* 2 The Clamping voltage tolerance at 12~18V(+/-15%), exceed 22V (+/-10%). Clamping voltage measured at standard current (A) : 10 A
- \* 3 The Peak Current was tested at 8/20 us waveform
- \* 4. The capacitance value and Energy only for customer reference, it's not formal specification Capacitance value measured at standard frequency : 1 MHz

SURGE LEVEL IEC61000-4-5

Severity Level	(kV)
1	0,5
2	1
3	2
4	4
X	Special

Wave shape "Short circuit" (Current I<sub>sc</sub>)

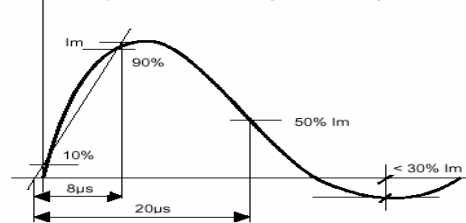

Wave during	T1	T2
8/20 μs	8 μs	20 μs
10/700 μs CCITT	10 μs	700 μs
10/1000 μs	10 μs	1000 μs

REFERENCE DATA

Response time	T <sub>rise</sub>	<	1	ns
Leakage current at V <sub>v</sub> × 80%	I <sub>VV</sub>	<	50	μA
Leakage current at V <sub>v</sub> × 80% (After reliability Test)	I <sub>VVA</sub>	<	200	μA
Operating ambient temperature			-40~+125	°C
Storage temperature			-50~+125	°C
Max. temperature solder			260	°C

OTHER DATA

Body	ZnO
End termination	Ag/Ni/Sn
Packaging	Reel
Complies with Standard	IEC61000-4-5
Procedure	Solgel
Marking	None

**Würth Elektronik eiSos GmbH & Co.KG - Radialex department**

D-74638 Waldenburg · Max-Eyth-Straße 1 - 3 · Germany · Telefon (+49) (0) 7942 - 945 - 0 · Telefax (+49) (0) 7942 - 945 - 400  
<http://www.we-online.com>

Kunde / customer :

Artikelnummer / part number : **82531400**

Bezeichnung :

description : **1206 SMD VARISTOR**

SMD size: **1206**

**C Lötpad / soldering spec. :**

RECOMMENDED SOLDER PAD LAYOUT

(Unit : mm)

SISE	A	B	C	D
402	0.4~0.6	1.0~1.8	0.6~0.7	0.6~1.2
603	0.8~1.2	1.7~3.0	1.2~1.6	0.9~1.8
805	1.0~1.5	2.1~3.8	1.5~2.1	1.1~2.3
1206	1.8~2.5	3.0~5.8	1.8~2.6	1.2~3.3
1210	1.8~2.5	3.2~6.1	2.8~3.8	1.3~3.5
1812	2.5~3.5	4.0~7.3	3.3~4.5	1.5~3.8
2220	3.5~4.6	5.0~8.5	5.2~6.2	1.5~3.9
3220	5.2~6.4	9.5~10.8	5.6~6.0	2.0~2.8

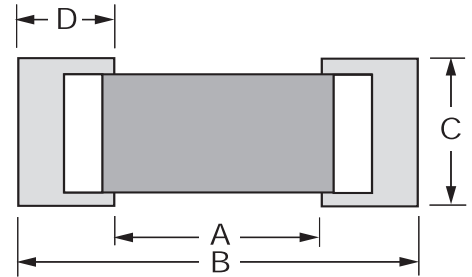

- 1 - The solder paste shall be printed in a thickness of 150 to 200µm.
- 2 - The SIR test of the solder paste shall be done (Based on JIS-Z-3284)
- 3 - IR reflow Pb Free Process suggestin profile (Based on J-STD-020-C):

Rapid heating, partial heating or rapid cooling will easily cause defect of the component. So preheating and gradual cooling process is suggested. IR soldering has the highest yields due to controlled heating rates and solder liquidus times. Make sure that the element is not subjected to a thermal gradient steeper than 3 degrees per second. 2 degrees per second is the ideal gradient. During the soldering process, pre- heating to within 175 degrees of the solders peak temperature is essential to minimize thermal shock.

Soldering recommend paste is Sn 96.5/Ag 3.5

- Preheat
  - 1.The temperature rising speed is suggested to be 2~3°C/s.
  - 2.Appropriate preheat time will be from 60 to 120 seconds.
  - 3.Temp. maintain at 175 +/-25°C 120 seconds.
- Heating
  - 1.Careful about sudden rise in temperature as it may worsen the solder ability.
  - 2.Set the peak temperature in 235°C 10-20s or 260°C 3-10s.
- Cooling
  - 1.Ramp down rate 6°C/s max.

※Perform adequate test in advance as the reflow temperature profile will vary according to the conditions of the manufacturing process, and the specification of the reflow furnace

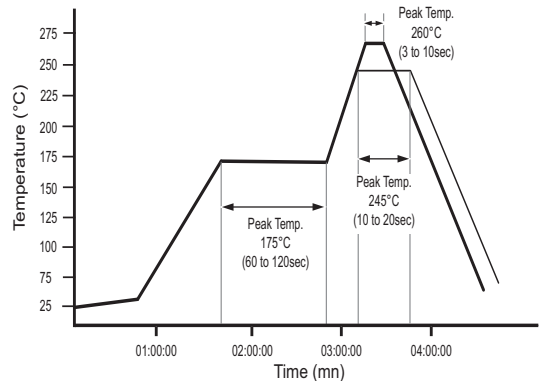

4 - Wave Soldering Process

Ramp-up rate 3°C/s max.  
 Temp. maintain at 175 +/-25°C 180 seconds max.  
 Peak temperature 260°C 3-10s.  
 Ramp down rate 6°C/s max.  
 to thermal shock, a preheat is recommended in the soldering process. and the peak temperature should be under controlled rigidly in the solder process.

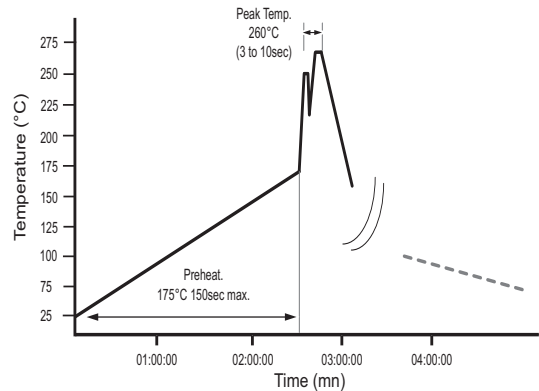

5 - Hand Soldering Process

Preheating 150°C  
 Temperature of soldering iron tip 380°C max. 3 to 5 sec  
 The Varistorrs shall be cooled gradually at room ambient temperature

6 - Ultrasonic cleaning

For preventing failures or damages. Frequency 29MHz max - radied Power 20W/l max - Period 5mn max

**Würth Elektronik eiSos GmbH & Co.KG - Radialex department**

D-74638 Waldenburg · Max-Eyth-Straße 1 - 3 · Germany · Telefon (+49) (0) 7942 - 945 - 0 · Telefax (+49) (0) 7942 - 945 - 400  
<http://www.we-online.com>

Kunde / customer :

Artikelnummer / part number : **82531400**

Bezeichnung :

description : **1206 SMD VARISTOR**

SMD size: **1206**

**D Rollenspezifikation / tape and reel specification :**

- 1 - Carrier tape and transparent cover tape should be heat-sealed to carry the products, and the reel should be used to reel the carrier tape.
- 2 - The adhesion of the heat-sealed cover tape shall be  $40 \pm 20 / - 15$ grams.
- 3 - Both the head and the end portion of the taping shall be empty for reel package and SMT auto-pickup machine.  
And a normal paper tape shall be connected in the head of taping for the operator to handle.

(Unit : mm)

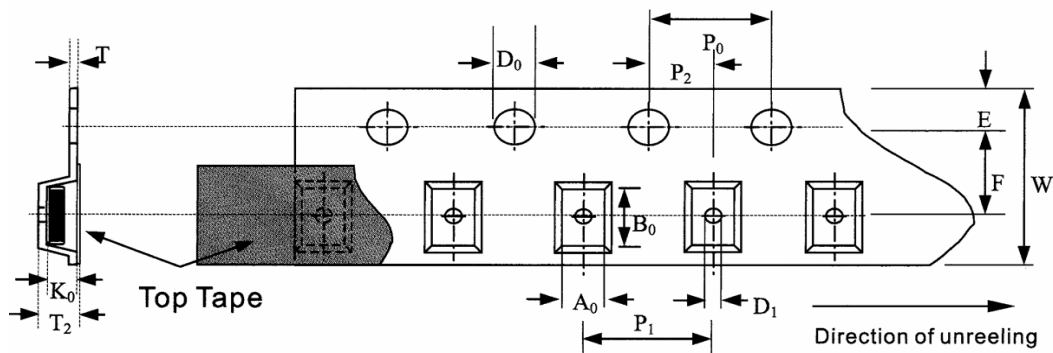

TAPE SPECIFICATION

(Unit : mm)

Symbol	$A_0$	$B_0$	$K_0$	$T_2$	$T$	$D_0$	$D_1$	$P_1$	$P_2$	$P_0$	$W$	$E$	$F$
	$\pm 0.10$	$\pm 0.10$	$\pm 0.10$	$\pm 0.05$	$\pm 0.05$	$+0.10$	$\pm 0.05$	$\pm 0.10$	$\pm 0.05$	$\pm 0.05$	$\pm 0.20$	$\pm 0.10$	$\pm 0.05$
						-0.00							
<b>402</b>	0.85	1.25	0.65	0.22	0.10	1.50	1.00	4.00	2.00	4.00	8.00	1.75	3.50
<b>603</b>	1.05	1.88	0.95	0.22	0.10	1.50	1.00	4.00	2.00	4.00	8.00	1.75	3.50
<b>805</b>	1.42	2.30	1.04	0.22	0.10	1.50	1.00	4.00	2.00	4.00	8.00	1.75	3.50
<b>1206</b>	1.88	3.50	1.27	0.2	0.10	1.50	1.00	4.00	2.00	4.00	8.00	1.75	3.50
<b>1210</b>	2.18	3.46	1.45	0.22	0.10	1.50	1.00	4.00	2.00	4.00	8.00	1.75	3.50
<b>1812</b>	3.66	4.95	1.74	0.25	0.10	1.50	1.50	8.00	2.00	4.00	12.00	1.75	5.50
<b>2220</b>	5.10	5.97	2.80	0.25	0.10	1.50	1.50	8.00	2.00	4.00	12.00	1.75	5.50

**Würth Elektronik eiSos GmbH & Co.KG - Radialex department**

D-74638 Waldenburg · Max-Eyth-Straße 1 - 3 · Germany · Telefon (+49) (0) 7942 - 945 - 0 · Telefax (+49) (0) 7942 - 945 - 400  
<http://www.we-online.com>

Kunde / customer :

Artikelnummer / part number : **82531400**

Bezeichnung :

description : **1206 SMD VARISTOR**

SMD size: **1206**

**D Rollenspezifikation / tape and reel specification :**

(Unit : mm)

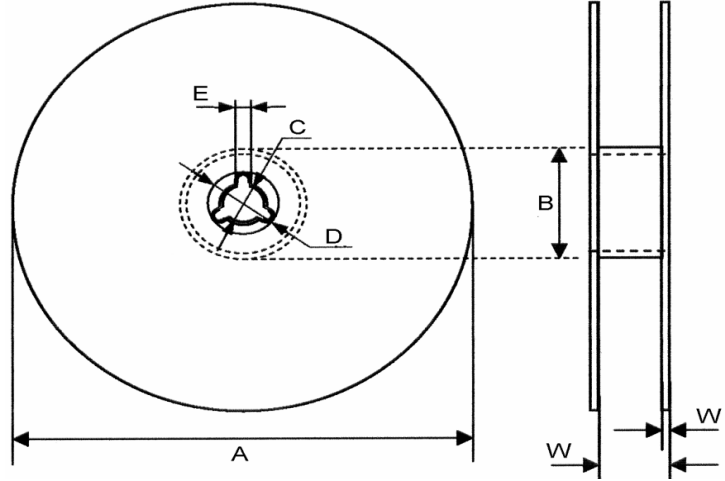

REEL DIMENSION

(Unit : mm)

Symbol	A	B	C	D	E	W	W <sub>1</sub>
<b>402</b>	178.0±1.0	60.0±0.5	13.0±0.2	21.0±0.2	2.0±0.5	9.0±0.50	1.5±0.15
<b>603</b>	178.0±1.0	60.0±0.5	13.0±0.2	21.0±0.2	2.0±0.5	9.0±0.50	1.5±0.15
<b>805</b>	178.0±1.0	60.0±0.5	13.0±0.2	21.0±0.2	2.0±0.5	9.0±0.50	1.5±0.15
<b>1206</b>	178.0±1.0	60.0±0.5	13.0±0.2	21.0±0.2	2.0±0.5	9.0±0.50	1.5±0.15
<b>1210</b>	178.0±1.0	60.0±0.5	13.0±0.2	21.0±0.2	2.0±0.5	9.0±0.50	1.5±0.15
<b>1812</b>	178.0±1.0	60.0±0.5	13.5±0.1	21.0±0.2	2.0±0.5	13.6±0.2	1.5±0.15
<b>2220</b>	178.0±1.0	60.0±0.5	13.5±0.1	21.0±0.2	2.0±0.5	13.6±0.2	1.5±0.15

\* 2.0 mm for 361 and 391

\* 2.5 mm for 431 and 471

QUANTITY PER PACKING UNIT

Type	402	603	805	1206	1210	1812	2220
<b>Pcs/reel</b>	10 000	4 000	3 000	3 000	2 000	1 000	1 000

Kunde / customer :

Artikelnummer / part number : **82531400**

Bezeichnung :

description : **1206 SMD VARISTOR**SMD size: **1206****E Testbedingungen / test conditions :**

## BASIC TEST

Characteristics	Test Method/Description
Standard Test Condition	Environmental condition under which every measuring is done without doubt on the measuring results. Unless specially specified, temperature, relative humidity are 5 to 35°C, 45 to 85 % RH.
Max. Working Voltage	Maximum steady-state DC operating voltage the device can maintain and typical leakage current at 25°C not exceed 50 µA.
Varistor Voltage	With the specified measuring current of 1mA DC applied.
Max. Clamping Voltage	Maximum peak voltage across the TVS measured at a specified pulse current (A) and waveform 8/20µs.
Surge Current	Maximum peak current which may be applied with the specified waveform 8/20µs without device failure.
Surge Shift $\Delta V/V$	The shift of TVS voltage after suffering the specified surge current.
Energy Absorption	Maximum energy which may be dissipated with a specified waveform 10/1000µs without device failure.
Typical Capacitance	Device Capacitance measured with zero voltage bias 0.5VRMS and 1KHZ
Leakage Current	Typical leakage current at 25°C < 50µA

## ENVIRONMENTAL RELIABILITY TEST

Characteristic	Test method and description															
High Temperature Storage	The specimen shall be subjected to 125 ± 2°C for 1000 ± 12 hours in a thermostatic bath without load and then stored at room temperature and humidity for 1 to 2 hours. The change of varistor voltage shall be within 10 %.															
Temperature Cycle	The temperature cycle of specified temperature shall be repeated five times and then stored at room temperature and humidity for one or two hours. the change of varistor voltage shall be within 10 % and mechanical damage shall be examined. <table border="1" data-bbox="466 1249 1023 1413"> <thead> <tr> <th>Step</th> <th>Temperature</th> <th>Period</th> </tr> </thead> <tbody> <tr> <td>1</td> <td>-40±3°C</td> <td>30Min±3</td> </tr> <tr> <td>2</td> <td>Room Temperature</td> <td>1-2 hours</td> </tr> <tr> <td>3</td> <td>125±2°C</td> <td>30Min±3</td> </tr> <tr> <td>4</td> <td>Temperature</td> <td>1-2 hours</td> </tr> </tbody> </table>	Step	Temperature	Period	1	-40±3°C	30Min±3	2	Room Temperature	1-2 hours	3	125±2°C	30Min±3	4	Temperature	1-2 hours
Step	Temperature	Period														
1	-40±3°C	30Min±3														
2	Room Temperature	1-2 hours														
3	125±2°C	30Min±3														
4	Temperature	1-2 hours														
High Temperature Load	After being continuously applied the maximum allowable voltage at 125 ± 2°C for 1000± 2 hours, the specimen shall be stored at room temperature and humidity for one or two hours, the change of varistor voltage shall be within 10 %.															
Damp Heat Load/Humidity Load	The specimen should be subjected to 40 ± 2°C, 90 to 95 % RH environment , and the maximum allowable voltage applied for 1000 hours, then stored at room temperature and humidity for one or two hours. the change of varistor voltage shall be within 10 %															
Low Temperature Storage	The specimen should be subjected to 40 ± 2°C, without load for 1000 hours and then stored at room temperature for one or two hours. the change of varistor voltage shall be within 10 %															

Freigabe erteilt / general release:	<b>Kunde / customer</b>				
Datum / date	Unterschrift / signature	JP. PENLOU	High Temperature Temp.	07-06-15	
	<b>Würth Elektronik</b>	JP. PENLOU	New P/N	06-06-02	
		JP. PENLOU	Operating temp. Range	05-11-30	
		JP. PENLOU	Lead free soldering	05-11-04	
Geprüft / checked	2006-06-02	Kontrolliert / approved	JP. Penlou	Name	Änderung / modification Datum / date

**Würth Elektronik eiSos GmbH & Co.KG - Radialex department**

D-74638 Waldenburg · Max-Eyth-Straße 1 - 3 · Germany · Telefon (+49) (0) 7942 - 945 - 0 · Telefax (+49) (0) 7942 - 945 - 400  
<http://www.we-online.com>