

HiPerFRED

$$V_{RRM} = 1200 \text{ V}$$

$$I_{FAV} = 2 \times 60 \text{ A}$$

$$t_{rr} = 40 \text{ ns}$$

High Performance Fast Recovery Diode
 Low Loss and Soft Recovery
 Common Cathode

Part number

DSEC120-12AK

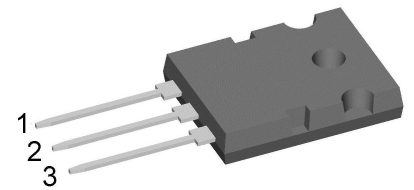

Backside: cathode

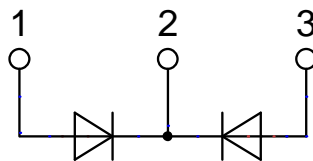
**Features / Advantages:**

- Planar passivated chips
- Very low leakage current
- Very short recovery time
- Improved thermal behaviour
- Very low I_{rm} -values
- Very soft recovery behaviour
- Avalanche voltage rated for reliable operation
- Soft reverse recovery for low EMI/RFI
- Low I_{rm} reduces:
 - Power dissipation within the diode
 - Turn-on loss in the commutating switch

Applications:

- Antiparallel diode for high frequency switching devices
- Antisaturation diode
- Snubber diode
- Free wheeling diode
- Rectifiers in switch mode power supplies (SMPS)
- Uninterruptible power supplies (UPS)

Package: TO-264

- Industry standard outline
- RoHS compliant
- Epoxy meets UL 94V-0

Terms .Conditions of usage:

The data contained in this product data sheet is exclusively intended for technically trained staff. The user will have to evaluate the suitability of the product for the intended application and the completeness of the product data with respect to his application. The specifications of our components may not be considered as an assurance of component characteristics. The information in the valid application- and assembly notes must be considered. Should you require product information in excess of the data given in this product data sheet or which concerns the specific application of your product, please contact your local sales office.

Due to technical requirements our product may contain dangerous substances. For information on the types in question please contact your local sales office.

Should you intend to use the product in aviation, in health or life endangering or life support applications, please notify. For any such application we urgently recommend

- to perform joint risk and quality assessments;

- the conclusion of quality agreements;

- to establish joint measures of an ongoing product survey, and that we may make delivery dependent on the realization of any such measures.

Fast Diode				Ratings			
Symbol	Definition	Conditions		min.	typ.	max.	Unit
V_{RSM}	max. non-repetitive reverse blocking voltage					1200	V
V_{RRM}	max. repetitive reverse blocking voltage					1200	V
I_R	reverse current, drain current	$V_R = 1200\text{ V}$		$T_{VJ} = 25^\circ\text{C}$		650	μA
		$V_R = 1200\text{ V}$		$T_{VJ} = 150^\circ\text{C}$		2.5	mA
V_F	forward voltage drop	$I_F = 60\text{ A}$		$T_{VJ} = 25^\circ\text{C}$		2.66	V
						$I_F = 120\text{ A}$	3.18
		$I_F = 60\text{ A}$		$T_{VJ} = 150^\circ\text{C}$		1.81	V
						$I_F = 120\text{ A}$	2.40
I_{FAV}	average forward current	$T_C = 115^\circ\text{C}$ rectangular	d = 0.5	$T_{VJ} = 175^\circ\text{C}$		60	A
V_{FO}	threshold voltage	} for power loss calculation only		$T_{VJ} = 175^\circ\text{C}$		1.08	V
r_F	slope resistance					9.4	m Ω
R_{thJC}	thermal resistance junction to case					0.45	K/W
R_{thCH}	thermal resistance case to heatsink				0.15		K/W
P_{tot}	total power dissipation			$T_C = 25^\circ\text{C}$		330	W
I_{FSM}	max. forward surge current	t = 10 ms; (50 Hz), sine; $V_R = 0\text{ V}$		$T_{VJ} = 45^\circ\text{C}$		500	A
C_J	junction capacitance	$V_R = 600\text{ V}$ f = 1 MHz		$T_{VJ} = 25^\circ\text{C}$		30	pF
I_{RM}	max. reverse recovery current	} $I_F = 60\text{ A}; V_R = 600\text{ V}$		$T_{VJ} = 25^\circ\text{C}$		13	A
				$T_{VJ} = 100^\circ\text{C}$		20	A
t_{rr}	reverse recovery time	} $-di_F/dt = 200\text{ A}/\mu\text{s}$		$T_{VJ} = 25^\circ\text{C}$		80	ns
				$T_{VJ} = 100^\circ\text{C}$		220	ns

Package TO-264			Ratings			
Symbol	Definition	Conditions	min.	typ.	max.	Unit
I_{RMS}	RMS current	per terminal 1)			70	A
T_{VJ}	virtual junction temperature		-55		175	°C
T_{op}	operation temperature		-55		150	°C
T_{stg}	storage temperature		-55		150	°C
Weight				10		g
M_D	mounting torque		0.8		1.2	Nm
F_C	mounting force with clip		20		120	N

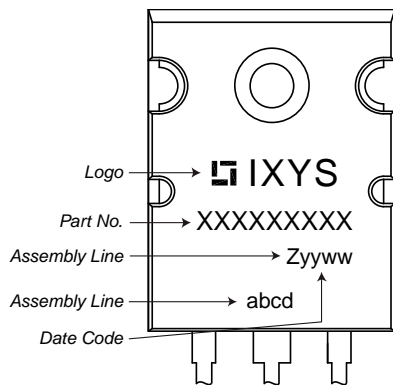

Ordering	Ordering Number	Marking on Product	Delivery Mode	Quantity	Code No.
Standard	DSEC120-12AK	DSEC120-12AK	Tube	25	498653

Equivalent Circuits for Simulation * on die level $T_{VJ} = 175^\circ\text{C}$

	Fast Diode	
$V_{0\ max}$	threshold voltage	1.08 V
$R_{0\ max}$	slope resistance *	6.8 mΩ

Outlines TO-264

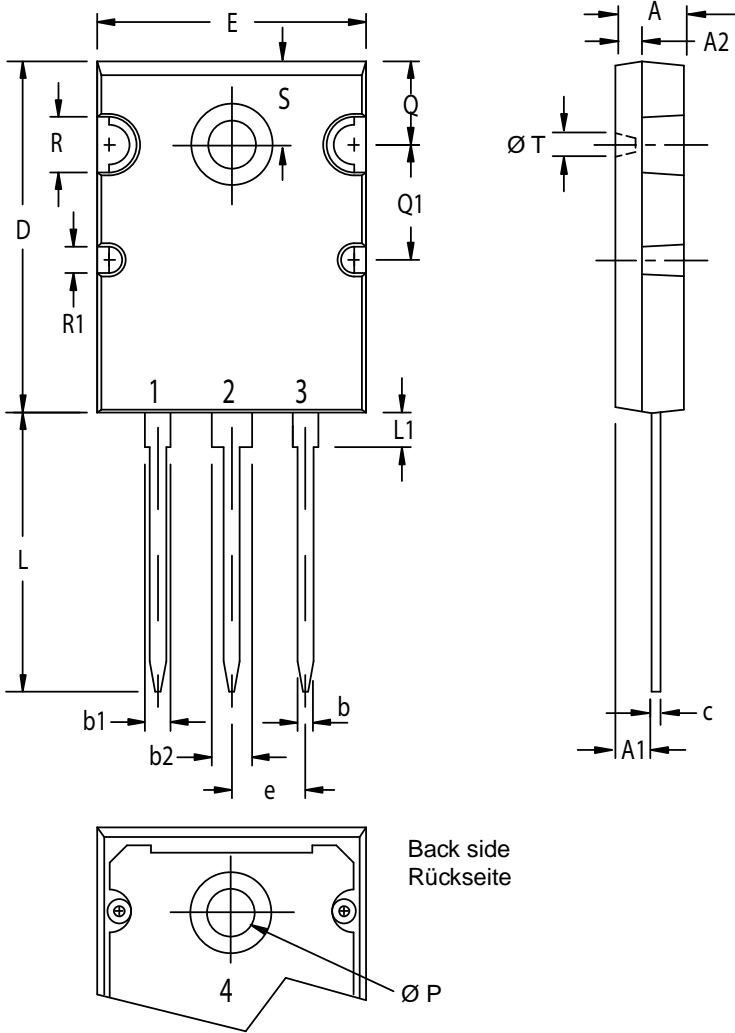

SYM	INCHES		MILLIMETERS	
	MIN	MAX	MIN	MAX
A	0.190	0.202	4.82	5.13
A1	0.100	0.114	2.54	2.89
A2	0.079	0.083	2.00	2.10
b	0.044	0.056	1.12	1.42
b1	0.094	0.106	2.39	2.69
b2	0.114	0.122	2.90	3.09
c	0.021	0.033	0.53	0.83
D	1.020	1.030	25.91	26.16
E	0.780	0.786	19.81	19.96
e	5.46 BSC		.215 BSC	
J	0.000	0.010	0.00	0.25
K	0.000	0.010	0.00	0.25
L	0.800	0.820	20.32	20.83
L1	0.090	0.102	2.29	2.59
P	0.125	0.144	3.17	3.66
Q	0.239	0.247	6.07	6.27
Q1	0.330	0.342	8.38	8.69
R	0.150	0.170	3.81	4.32
R1	0.070	0.090	1.78	2.29
S	0.238	0.248	6.04	6.30
T	0.062	0.072	1.57	1.83

Back side
Rückseite

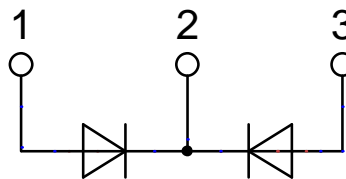

Fast Diode

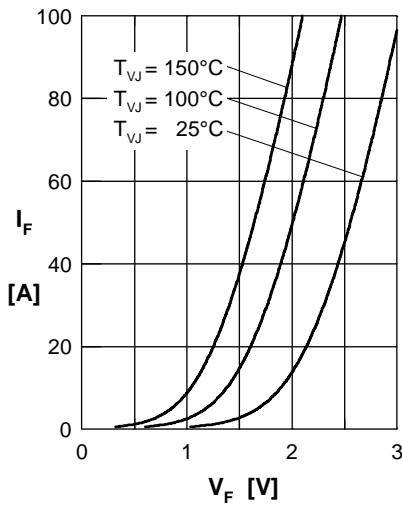

Fig. 1 Forward current I_F versus V_F

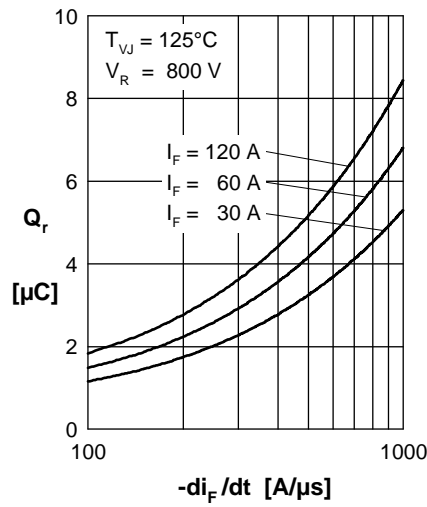

Fig. 2 Typ. reverse recov. charge Q_r versus $-di_F/dt$

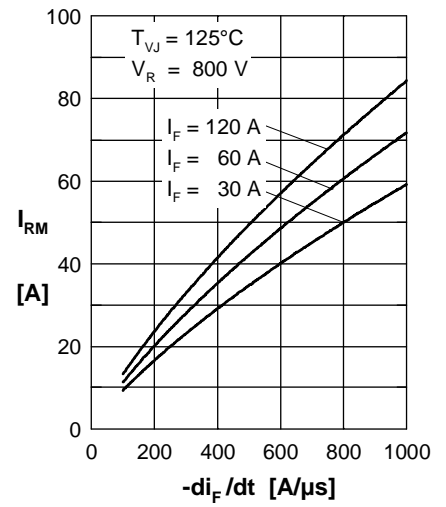

Fig. 3 Typ. peak reverse current I_{RM} versus $-di_F/dt$

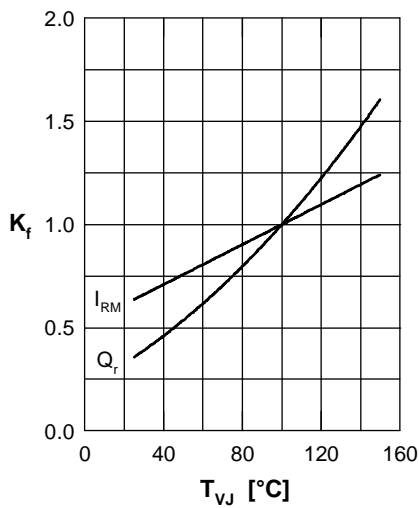

Fig. 4 Typ. dynamic parameters Q_r , I_{RM} versus T_{VJ}

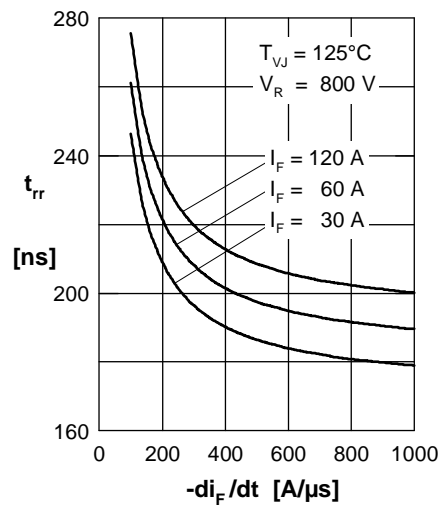

Fig. 5 Typ. recovery time t_{rr} versus $-di_F/dt$

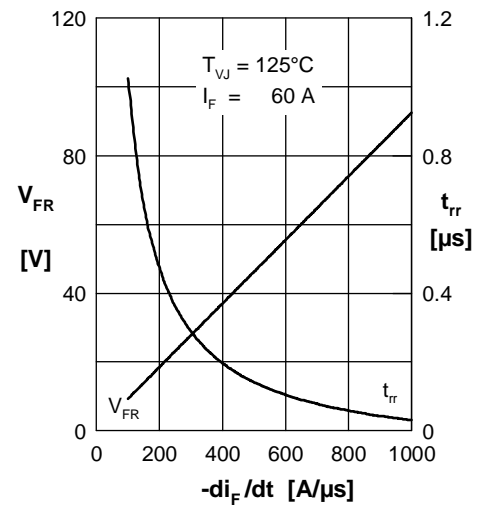

Fig. 6 Typ. peak forward voltage V_{FR} and t_{rr} versus di_F/dt

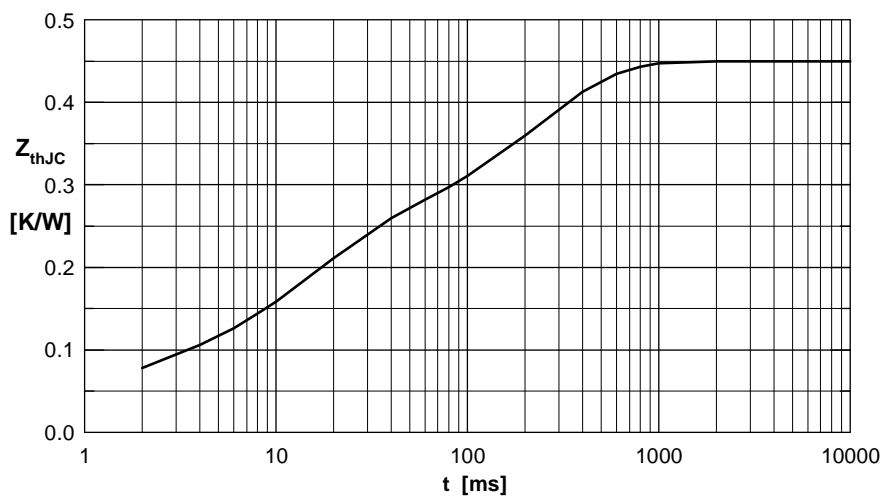

Fig. 7 Transient thermal resistance junction to case

Constants for Z_{thJC} calculation:

i	R_{thi} (K/W)	t_i (s)
1	0.0050	0.0001
2	0.0550	0.0010
3	0.1750	0.0140
4	0.2150	0.2300