

LOC	DIST	REVISIONS					
E	B	P	LTR	DESCRIPTION	DATE	DWN	APVD
		BA		NEW RELEASE	22-OCT-09	MRS	St.P

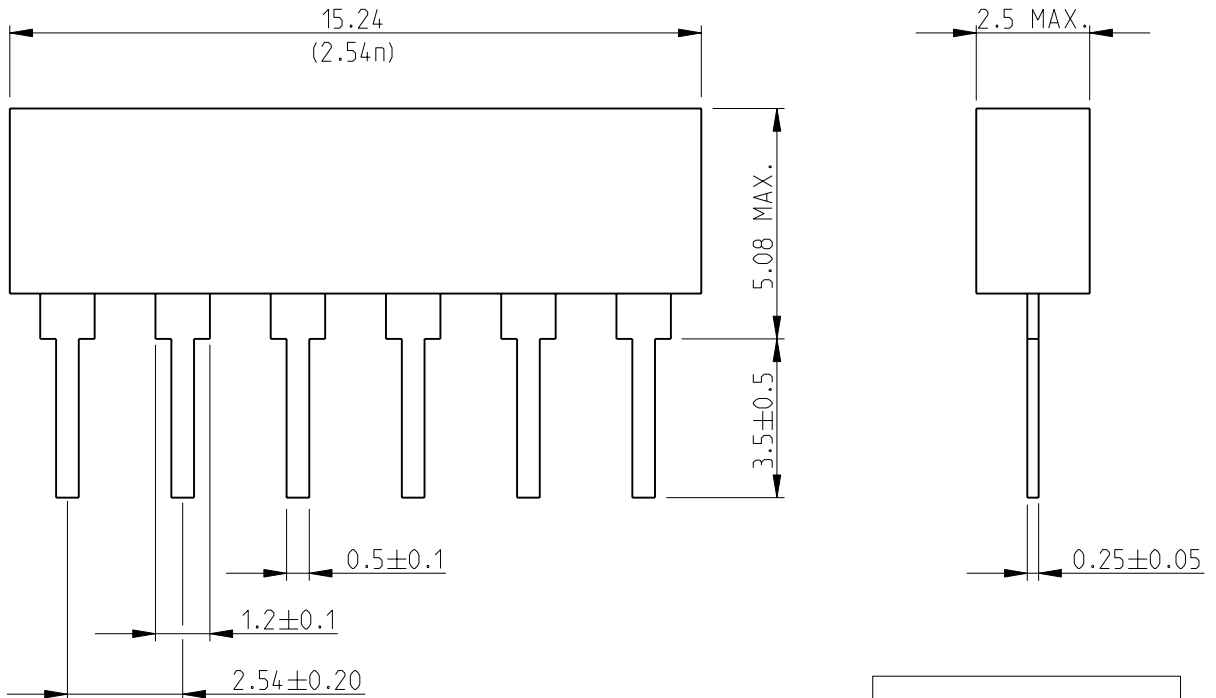

RoHS Compliant

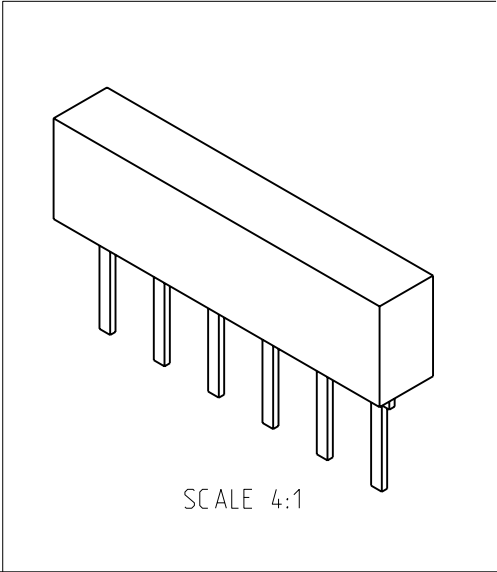

1. n = NUMBER OF PINS
2. FOR FURTHER INFORMATION SEE DATA SHEET FOR SERIES SIL, GENERAL PURPOSE RESISTOR NETWORKS

2009

RELEASED FOR PUBLICATION

THIS DRAWING IS UNPUBLISHED.

BY TYCO ELECTRONICS CORPORATION. ALL RIGHTS RESERVED.

© COPYRIGHT 2009

DIMENSIONS: mm	DWN MAHARUDRA	22-OCT-09	MATERIAL	-	FINISH	-
	CHK ALLAN.P	22-OCT-09	Tyco Electronics Corporation Dorcan, Swindon, SN3 5HH			
TOLERANCES UNLESS OTHERWISE SPECIFIED:	APVD STEPHEN.P	22-OCT-09				
	0 PLC ±0.2	PRODUCT SPEC	NAME GENERAL PURPOSE RESISTOR NETWORKS SIL06 RESISTOR NETWORKS			
1 PLC ±0.1	APPLICATION SPEC	SIZE A 4 CAGE CODE 00779 DRAWING NO C-1622802 RESTRICTED TO -				
2 PLC ±	WEIGHT	-	SCALE 6:1 SHEET 1 OF 1 REV BA			
3 PLC ±	CUSTOMER DRAWING					
4 PLC ±						
ANGLES ±5°						