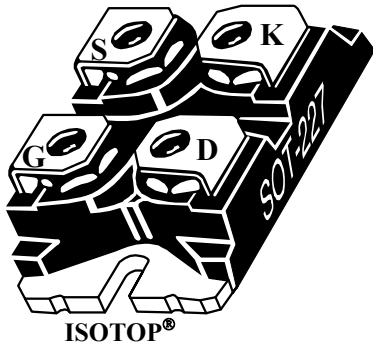
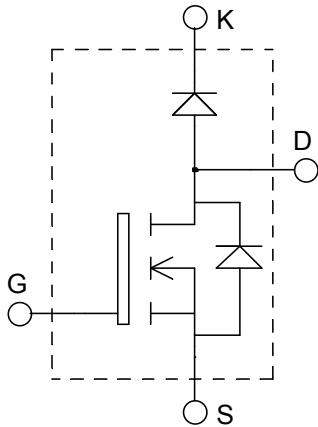


*ISOTOP<sup>®</sup> Boost chopper  
 Super Junction  
 MOSFET Power Module*


**$V_{DSS} = 600V$**   
 **$R_{DSon} = 70m\Omega \text{ max @ } T_j = 25^\circ C$**   
 **$I_D = 40A \text{ @ } T_c = 25^\circ C$**



### Application

- AC and DC motor control
- Switched Mode Power Supplies
- Power Factor Correction
- Brake switch

### Features

-  **COOLMOS**  
Power Semiconductors
  - Ultra low  $R_{DSon}$
  - Low Miller capacitance
  - Ultra low gate charge
  - Avalanche energy rated
- ISOTOP<sup>®</sup> Package (SOT-227)
- Very low stray inductance
- High level of integration

### Benefits

- Outstanding performance at high frequency operation
- Stable temperature behavior
- Very rugged
- Direct mounting to heatsink (isolated package)
- Low junction to case thermal resistance
- Easy paralleling due to positive  $T_C$  of  $V_{CEsat}$
- RoHS Compliant

### Absolute maximum ratings

Symbol	Parameter	Max ratings	Unit
$V_{DSS}$	Drain - Source Breakdown Voltage	600	V
$I_D$	Continuous Drain Current	$T_c = 25^\circ C$	40
		$T_c = 80^\circ C$	30
$I_{DM}$	Pulsed Drain current	120	
$V_{GS}$	Gate - Source Voltage	$\pm 20$	V
$R_{DSon}$	Drain - Source ON Resistance	70	$m\Omega$
$P_D$	Maximum Power Dissipation	$T_c = 25^\circ C$	290
$I_{AR}$	Avalanche current (repetitive and non repetitive)	20	A
$E_{AR}$	Repetitive Avalanche Energy	1	$mJ$
$E_{AS}$	Single Pulse Avalanche Energy	1800	
$IF_{AV}$	Maximum Average Forward Current	Duty cycle=0.5 $T_c = 80^\circ C$	30
$IF_{RMS}$	RMS Forward Current (Square wave, 50% duty)		39

 **CAUTION:** These Devices are sensitive to Electrostatic Discharge. Proper Handling Procedures Should Be Followed.

All ratings @  $T_j = 25^\circ\text{C}$  unless otherwise specified

**Electrical Characteristics**

Symbol	Characteristic	Test Conditions	Min	Typ	Max	Unit
I <sub>DSS</sub>	Zero Gate Voltage Drain Current	V <sub>GS</sub> = 0V, V <sub>DS</sub> = 600V   T <sub>j</sub> = 25°C			25	μA
		V <sub>GS</sub> = 0V, V <sub>DS</sub> = 600V   T <sub>j</sub> = 125°C			250	
R <sub>DS(on)</sub>	Drain – Source on Resistance	V <sub>GS</sub> = 10V, I <sub>D</sub> = 20A			70	mΩ
V <sub>GS(th)</sub>	Gate Threshold Voltage	V <sub>GS</sub> = V <sub>DS</sub> , I <sub>D</sub> = 1mA	2.1	3	3.9	V
I <sub>GSS</sub>	Gate – Source Leakage Current	V <sub>GS</sub> = ±20 V, V <sub>DS</sub> = 0V			±100	nA

**Dynamic Characteristics**

Symbol	Characteristic	Test Conditions	Min	Typ	Max	Unit
C <sub>iss</sub>	Input Capacitance	V <sub>GS</sub> = 0V V <sub>DS</sub> = 25V f = 1MHz		7015		pF
C <sub>oss</sub>	Output Capacitance			2565		
C <sub>rss</sub>	Reverse Transfer Capacitance			212		
Q <sub>g</sub>	Total gate Charge	V <sub>GS</sub> = 10V V <sub>Bus</sub> = 300V I <sub>D</sub> = 40A		259		nC
Q <sub>gs</sub>	Gate – Source Charge			29		
Q <sub>gd</sub>	Gate – Drain Charge			111		
T <sub>d(on)</sub>	Turn-on Delay Time	<b>Resistive Switching</b> V <sub>GS</sub> = 15V V <sub>Bus</sub> = 380V I <sub>D</sub> = 40A R <sub>G</sub> = 1.8Ω		20		ns
T <sub>r</sub>	Rise Time			30		
T <sub>d(off)</sub>	Turn-off Delay Time			115		
T <sub>f</sub>	Fall Time			10		
E <sub>on</sub>	Turn-on Switching Energy	<b>Inductive switching @ 25°C</b> V <sub>GS</sub> = 15V, V <sub>Bus</sub> = 400V I <sub>D</sub> = 40A, R <sub>G</sub> = 5Ω		670		μJ
E <sub>off</sub>	Turn-off Switching Energy			980		
E <sub>on</sub>	Turn-on Switching Energy	<b>Inductive switching @ 125°C</b> V <sub>GS</sub> = 15V, V <sub>Bus</sub> = 400V I <sub>D</sub> = 40A, R <sub>G</sub> = 5Ω		1100		μJ
E <sub>off</sub>	Turn-off Switching Energy			1206		

**Chopper diode ratings and characteristics**

Symbol	Characteristic	Test Conditions	Min	Typ	Max	Unit
V <sub>F</sub>	Diode Forward Voltage	I <sub>F</sub> = 30A		1.6	1.8	V
		I <sub>F</sub> = 60A		1.9		
		I <sub>F</sub> = 30A	T <sub>j</sub> = 125°C	1.4		
I <sub>RM</sub>	Maximum Reverse Leakage Current	V <sub>R</sub> = 600V			250	μA
		V <sub>R</sub> = 600V	T <sub>j</sub> = 125°C		500	
C <sub>T</sub>	Junction Capacitance	V <sub>R</sub> = 200V		44		pF
t <sub>rr</sub>	Reverse Recovery Time	I <sub>F</sub> = 1A, V <sub>R</sub> = 30V di/dt = 100A/μs	T <sub>j</sub> = 25°C	23		ns
	Reverse Recovery Time		T <sub>j</sub> = 25°C	85		
			T <sub>j</sub> = 125°C	160		
I <sub>RRM</sub>	Maximum Reverse Recovery Current	I <sub>F</sub> = 30A V <sub>R</sub> = 400V di/dt = 200A/μs	T <sub>j</sub> = 25°C	4		A
			T <sub>j</sub> = 125°C	8		
			T <sub>j</sub> = 125°C	130		
Q <sub>rr</sub>	Reverse Recovery Charge		T <sub>j</sub> = 25°C	700		nC
			T <sub>j</sub> = 125°C	700		
t <sub>rr</sub>	Reverse Recovery Time	I <sub>F</sub> = 30A	T <sub>j</sub> = 125°C	70		ns
Q <sub>rr</sub>	Reverse Recovery Charge	V <sub>R</sub> = 400V		1300		nC
I <sub>RRM</sub>	Maximum Reverse Recovery Current	di/dt = 1000A/μs		30		A

**Thermal and package characteristics**

Symbol	Characteristic	Min	Typ	Max	Unit
R <sub>thJC</sub>	Junction to Case Thermal Resistance	CoolMos		0.43	°C/W
		Diode		1.21	
R <sub>thJA</sub>	Junction to Ambient (IGBT & Diode)			20	
V <sub>ISOL</sub>	RMS Isolation Voltage, any terminal to case t = 1 min, 50/60Hz	2500			V
T <sub>J</sub> , T <sub>STG</sub>	Storage Temperature Range	-55		150	°C
T <sub>L</sub>	Max Lead Temp for Soldering: 0.063" from case for 10 sec			300	
Torque	Mounting torque (Mounting = 8-32 or 4mm Machine and terminals = 4mm Machine)			1.5	N.m
Wt	Package Weight		29.2		g

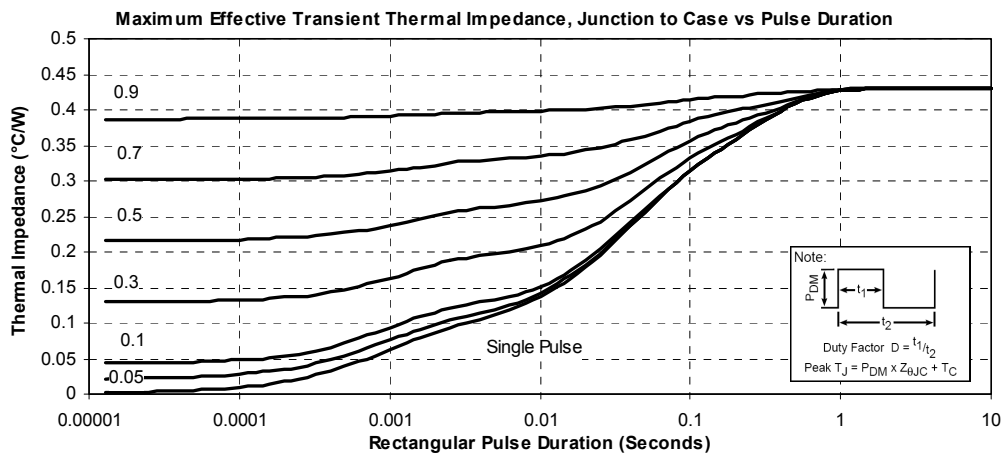
**Typical CoolMOS Performance Curve**


Fig 1, Maximum Effective transient thermal Impedance, Junction to case vs Pulse Duration

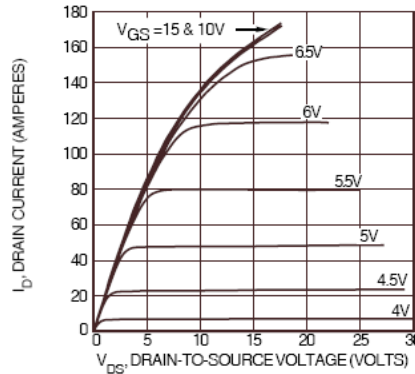


FIGURE 3. LOW VOLTAGE OUTPUT CHARACTERISTICS

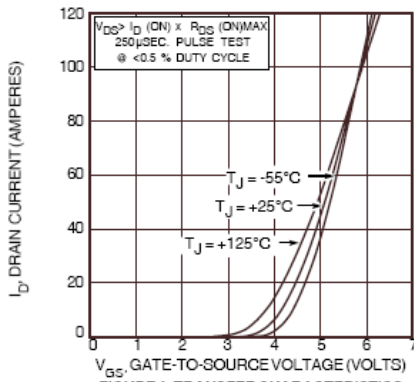


FIGURE 4. TRANSFER CHARACTERISTICS

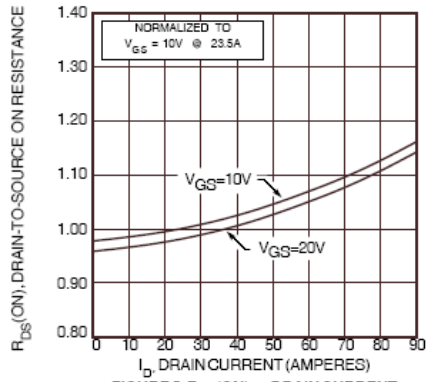


FIGURE 5.  $R_{DS(\text{ON})}$  vs DRAIN CURRENT

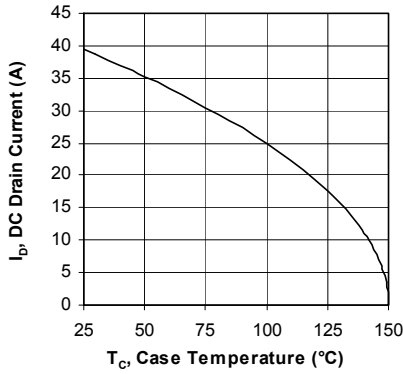


Figure 6. DC Drain Current vs Case Temperature

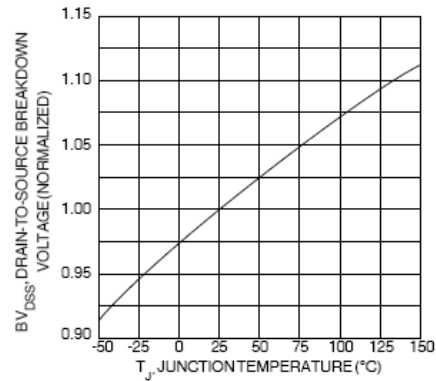


FIGURE 7. BREAKDOWN VOLTAGE vs TEMPERATURE

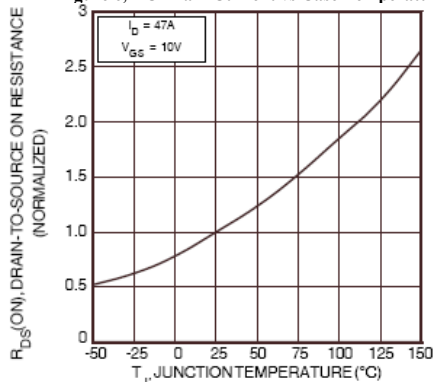


FIGURE 8. ON-RESISTANCE vs. TEMPERATURE

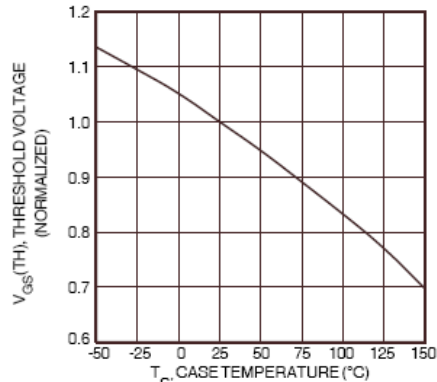


FIGURE 9. THRESHOLD VOLTAGE vs TEMPERATURE

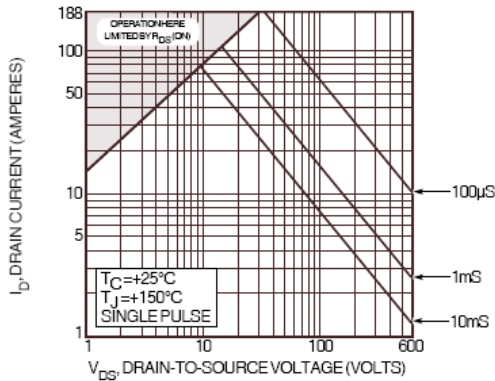


FIGURE 10, MAXIMUM SAFE OPERATING AREA

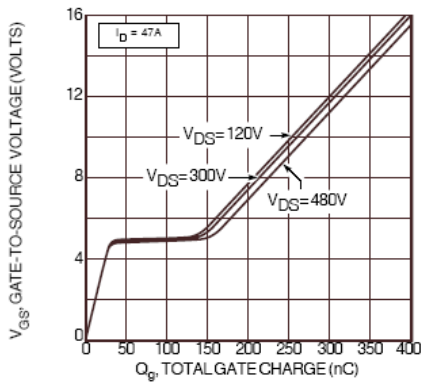


FIGURE 12, GATE CHARGES vs GATE-TO-SOURCE VOLTAGE

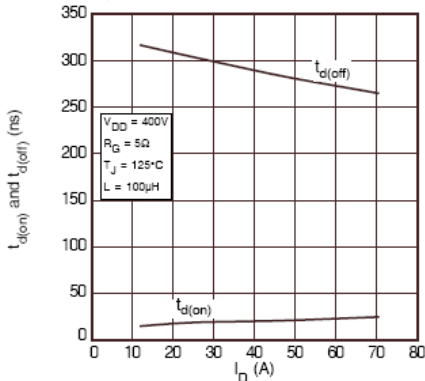


FIGURE 14, DELAY TIMES vs CURRENT

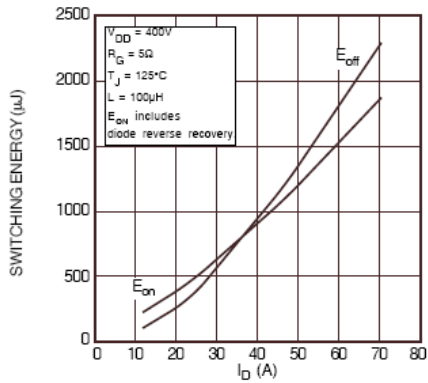


FIGURE 16, SWITCHING ENERGY vs CURRENT

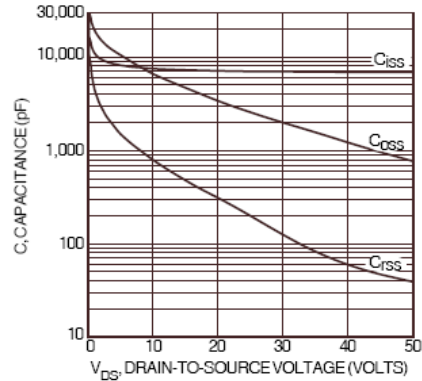


FIGURE 11, CAPACITANCE vs DRAIN-TO-SOURCE VOLTAGE

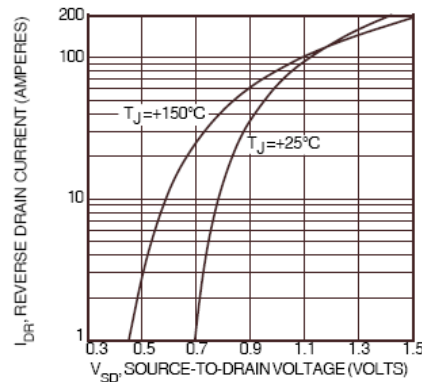


FIGURE 13, SOURCE-DRAIN DIODE FORWARD VOLTAGE

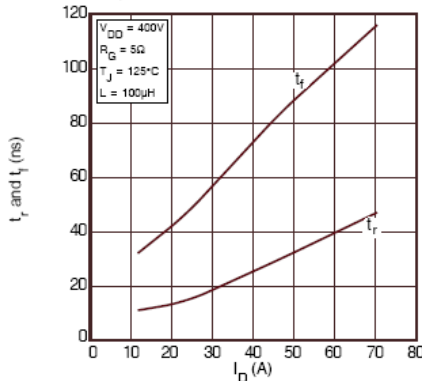


FIGURE 15, RISE AND FALL TIMES vs CURRENT

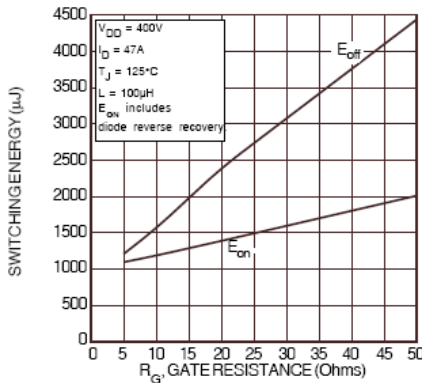


FIGURE 17, SWITCHING ENERGY vs. GATE RESISTANCE

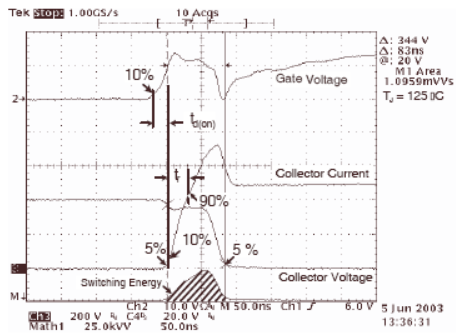


Figure 18, Turn-on Switching Waveforms and Definitions

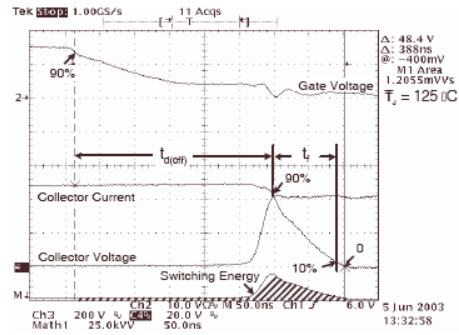


Figure 19, Turn-off Switching Waveforms and Definitions

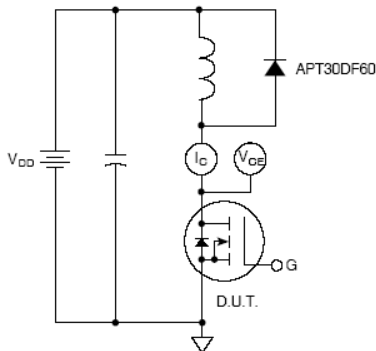


Figure 20, Inductive Switching Test Circuit

## Typical Diode Performance Curve

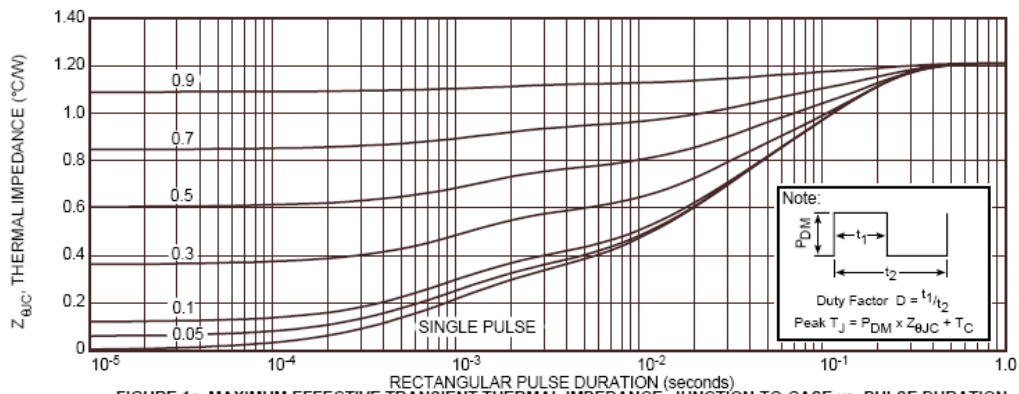


FIGURE 1a. MAXIMUM EFFECTIVE TRANSIENT THERMAL IMPEDANCE, JUNCTION-TO-CASE vs. PULSE DURATION

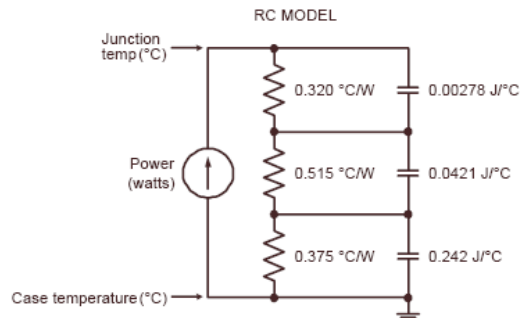


FIGURE 1b, TRANSIENT THERMAL IMPEDANCE MODEL

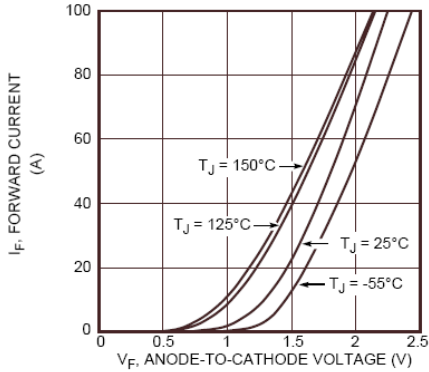


Figure 2. Forward Current vs. Forward Voltage

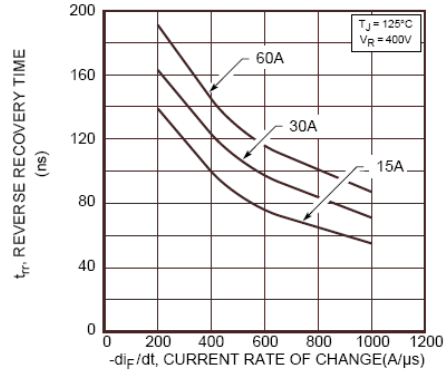


Figure 3. Reverse Recovery Time vs. Current Rate of Change

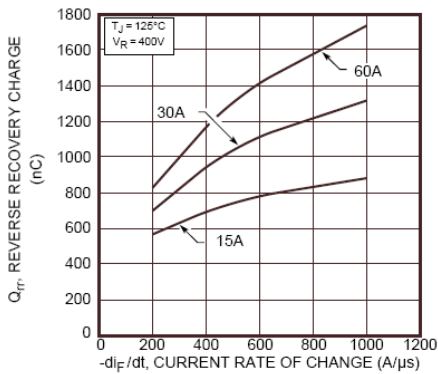


Figure 4. Reverse Recovery Charge vs. Current Rate of Change

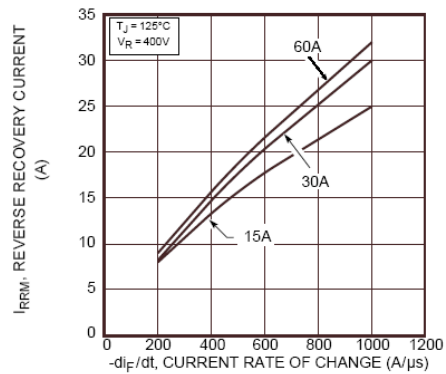


Figure 5. Reverse Recovery Current vs. Current Rate of Change

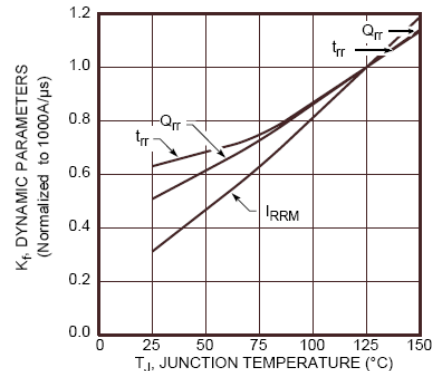


Figure 6. Dynamic Parameters vs. Junction Temperature

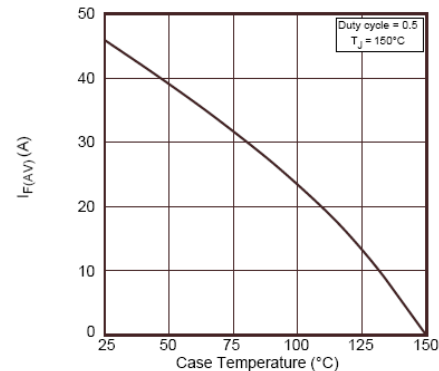


Figure 7. Maximum Average Forward Current vs. Case Temperature

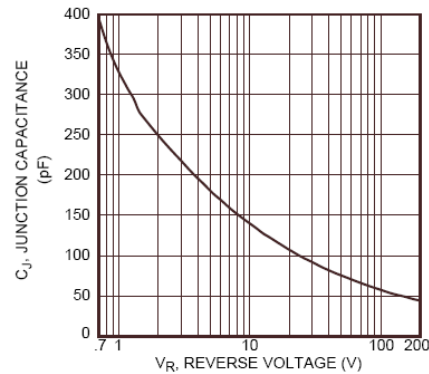


Figure 8. Junction Capacitance vs. Reverse Voltage

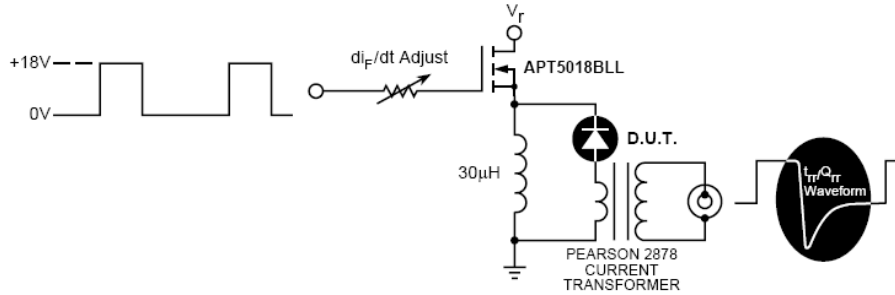


Figure 9. Diode Test Circuit

- ❶  $I_F$  - Forward Conduction Current
- ❷  $di_F/dt$  - Rate of Diode Current Change Through Zero Crossing.
- ❸  $I_{RRM}$  - Maximum Reverse Recovery Current.
- ❹  $t_{rr}$  - Reverse Recovery Time, measured from zero crossing where diode current goes from positive to negative, to the point at which the straight line through  $I_{RRM}$  and  $0.25 \cdot I_{RRM}$  passes through zero.
- ❺  $Q_{rr}$  - Area Under the Curve Defined by  $I_{RRM}$  and  $t_{rr}$ .

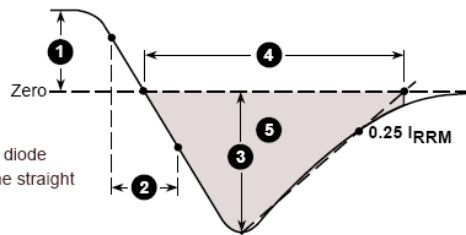
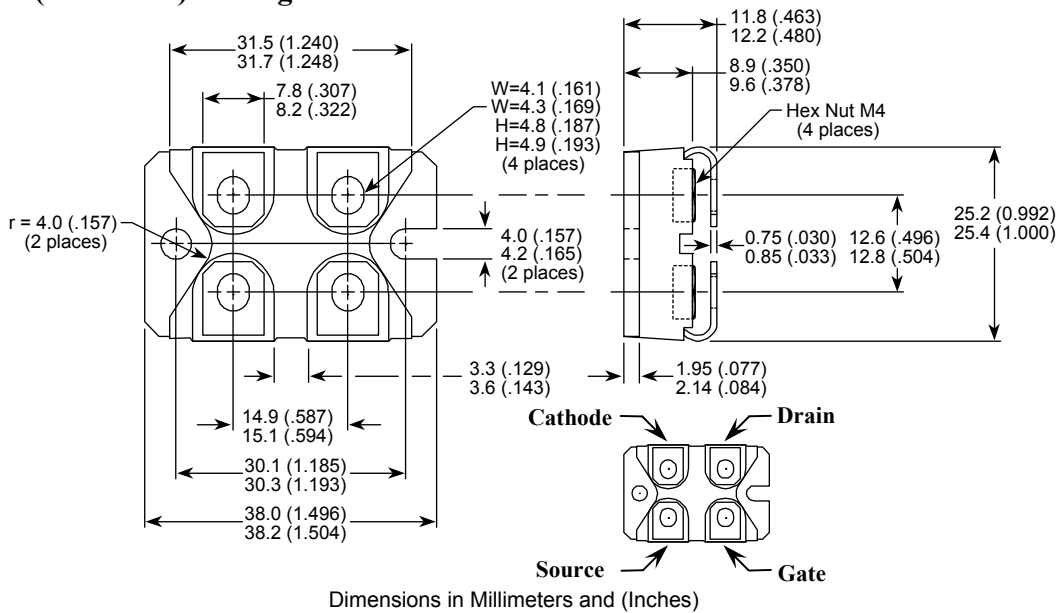


Figure 10. Diode Reverse Recovery Waveform and Definitions

**SOT-227 (ISOTOP<sup>®</sup>) Package Outline**



“COOLMOS<sup>™</sup> comprise a new family of transistors developed by Infineon Technologies AG. “COOLMOS” is a trademark of Infineon Technologies AG”.

ISOTOP<sup>®</sup> is a registered trademark of ST Microelectronics NV



DISCLAIMER

The information contained in the document (unless it is publicly available on the Web without access restrictions) is PROPRIETARY AND CONFIDENTIAL information of Microsemi and cannot be copied, published, uploaded, posted, transmitted, distributed or disclosed or used without the express duly signed written consent of Microsemi. If the recipient of this document has entered into a disclosure agreement with Microsemi, then the terms of such Agreement will also apply. This document and the information contained herein may not be modified, by any person other than authorized personnel of Microsemi. No license under any patent, copyright, trade secret or other intellectual property right is granted to or conferred upon you by disclosure or delivery of the information, either expressly, by implication, inducement, estoppels or otherwise. Any license under such intellectual property rights must be approved by Microsemi in writing signed by an officer of Microsemi.

Microsemi reserves the right to change the configuration, functionality and performance of its products at anytime without any notice. This product has been subject to limited testing and should not be used in conjunction with life-support or other mission-critical equipment or applications. Microsemi assumes no liability whatsoever, and Microsemi disclaims any express or implied warranty, relating to sale and/or use of Microsemi products including liability or warranties relating to fitness for a particular purpose, merchantability, or infringement of any patent, copyright or other intellectual property right. Any performance specifications believed to be reliable but are not verified and customer or user must conduct and complete all performance and other testing of this product as well as any user or customers final application. User or customer shall not rely on any data and performance specifications or parameters provided by Microsemi. It is the customer's and user's responsibility to independently determine suitability of any Microsemi product and to test and verify the same. The information contained herein is provided "AS IS, WHERE IS" and with all faults, and the entire risk associated with such information is entirely with the User. Microsemi specifically disclaims any liability of any kind including for consequential, incidental and punitive damages as well as lost profit. The product is subject to other terms and conditions which can be located on the web at <http://www.microsemi.com/legal/tnc.asp>

Life Support Application

Seller's Products are not designed, intended, or authorized for use as components in systems intended for space, aviation, surgical implant into the body, in other applications intended to support or sustain life, or for any other application in which the failure of the Seller's Product could create a situation where personal injury, death or property damage or loss may occur (collectively "Life Support Applications").

Buyer agrees not to use Products in any Life Support Applications and to the extent it does it shall conduct extensive testing of the Product in such applications and further agrees to indemnify and hold Seller, and its officers, employees, subsidiaries, affiliates, agents, sales representatives and distributors harmless against all claims, costs, damages and expenses, and attorneys' fees and costs arising, directly or indirectly, out of any claims of personal injury, death, damage or otherwise associated with the use of the goods in Life Support Applications, even if such claim includes allegations that Seller was negligent regarding the design or manufacture of the goods.

Buyer must notify Seller in writing before using Seller's Products in Life Support Applications. Seller will study with Buyer alternative solutions to meet Buyer application specification based on Sellers sales conditions applicable for the new proposed specific part.