

ASM2I9940L

Low Voltage 1:18 Clock Distribution Chip

Functional Description

The ASM2I9940L is a 1:18 low Voltage Clock distribution chip with 2.5 V or 3.3 V LVCMOS output capabilities. The device features the capability to select either a differential LVPECL or LVCMOS compatible input. The 18 outputs are 2.5 V or 3.3 V LVCMOS compatible and feature the drive strength to drive 50 Ω series or parallel terminated transmission lines. With output-to-output skews of 150 pS, the ASM2I9940L is ideal as a clock distribution chip for the most demanding of Synchronous systems. The 2.5 V outputs also make the device ideal for supplying clocks for a high performance microprocessor based design.

With low output impedance ($\approx 20 \Omega$), in both the HIGH and LOW logic states, the output buffers of the ASM2I9940L are ideal for driving series terminated transmission lines. With a 20 Ω output impedance the ASM2I9940L has the capability of driving two series terminated lines from each output. This gives the device an effective fanout of 1:36.

The differential LVPECL inputs of the ASM2I9940L allow the device to interface directly with a LVPECL fanout buffer to build very wide clock fanout trees or to couple to a high frequency clock source. The LVCMOS input provides a more standard interface for applications requiring only a single clock distribution chip at relatively low frequencies. In addition, the two clock sources can be used to provide for a test clock interface as well as the primary system clock. A logic HIGH on the LVCMOS_CLK_Sel pin will select the LVCMOS level clock input. All inputs of the ASM2I9940L have internal pullup/pulldown resistor, so they can be left open if unused.

The ASM2I9940L is a single or dual supply device. The device power supply offers a high degree of flexibility. The device can operate with a 3.3 V core and 3.3 V output, a 3.3 V core and 2.5 V outputs as well as a 2.5 V core and 2.5 V outputs. The 32-lead LQFP Package was chosen to optimize performance, board space and cost of the device. The 32-lead LQFP Package has a 7 x 7 mm² body size with conservative 0.8 mm pin spacing.

Features

- LVPECL or LVCMOS Clock Input
- 2.5 V LVCMOS Outputs for Intel® Pentium® II Microprocessor Support
- 150 pS Maximum Output-to-Output Skew
- Maximum Output Frequency of 250 MHz
- 32 Lead LQFP Package
- Dual or Single Supply Device:
- ♦ Dual V_{CC} Supply Voltage, 3.3 V Core and 2.5 V Output
- ♦ Single 3.3 V V_{CC} Supply Voltage for 3.3 V Outputs
- ♦ Single 2.5 V V_{CC} Supply Voltage for 2.5 V I/O
- Pin and Function compatible to MPC940L, MPC9109, CY29940 and CY29940-1
- These Devices are Pb-Free, Halogen Free/BFR Free and are RoHS Compliant



ON Semiconductor®

<http://onsemi.com>

MARKING DIAGRAM

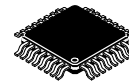

LQFP-32
CASE 873A

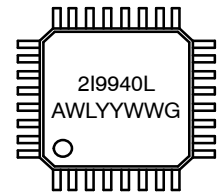

2I9940L = Specific Device Code
A = Assembly Location
WL = Wafer Lot
YY = Year
WW = Work Week
G = Pb-Free Package

ORDERING INFORMATION

See detailed ordering and shipping information in the package dimensions section on page 9 of this data sheet.

ASM2I9940L

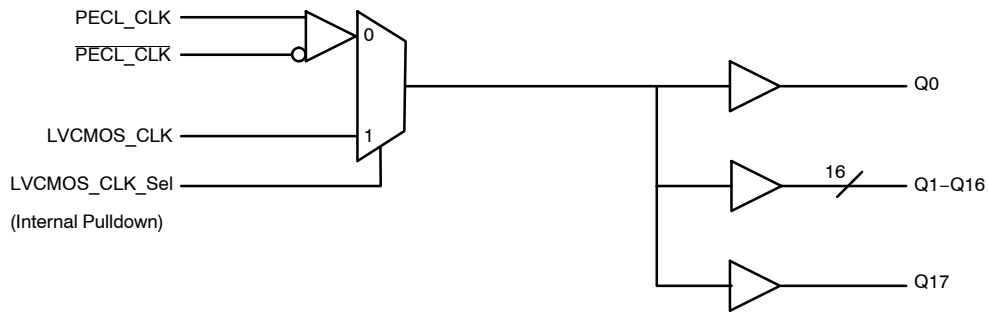

Figure 1. Block Diagram

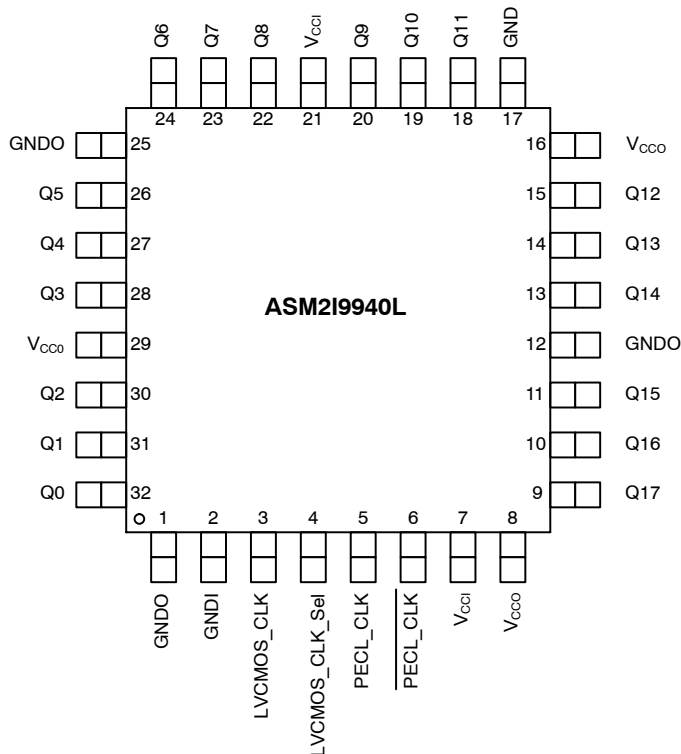

Figure 2. Pin Diagram

Table 1. FUNCTION TABLE

LVC MOS_CLK_Sel	Input
0	PECL_CLK
1	LVC MOS_CLK

Table 2. POWER SUPPLY VOLTAGES

Supply Pin	Voltage Level
VCCI	2.5 V or 3.3 V ± 5%
VCC0	2.5 V or 3.3 V ± 5%

ASM2I9940L

Table 3. PIN CONFIGURATIONS

Pin #	Pin Name	I/O	Type	Function
5 6	PECL_CLK PECL_CLK	Input	LVPECL	LVPECL Clock Inputs
3	LVCOSMOS_CLK	Input	LVCOSMOS	LVCOSMOS Clock Input
4	LVCOSMOS_CLK_Sel	Input	LVCOSMOS	Selects either LVPECL or LVCOSMOS input as Clock Source
32, 31, 30, 28, 27, 26, 24, 23, 22, 20, 19, 18, 15, 14, 13, 11, 10, 9	Q0 – Q17	Output	LVCOSMOS	Clock Outputs
2	GNDI		Supply	Core Negative Power Supply
1, 12, 17, 25	GNDO		Supply	Output Negative Power Supply
7, 21	V _{CCI}		Supply	Core Positive Power Supply
8, 16, 29	V _{CCO}		Supply	Output Positive Power Supply

Table 4. ABSOLUTE MAXIMUM RATINGS

Symbol	Parameter	Min	Max	Unit
V _{CC}	Supply Voltage	-0.3	3.6	V
V _I	Input Voltage	-0.3	V _{CC} + 0.3	V
I _{IN}	Input Current		± 20	mA
T _{Stor}	Storage Temperature Range	-40	125	°C
T _s	Max. Soldering Temperature (10 sec)		260	°C
T _{DV}	Static Discharge Voltage (As per JEDEC STD22-A114-B)		2	kV

Stresses exceeding Maximum Ratings may damage the device. Maximum Ratings are stress ratings only. Functional operation above the Recommended Operating Conditions is not implied. Extended exposure to stresses above the Recommended Operating Conditions may affect device reliability.

Table 5. DC CHARACTERISTICS (T_A = 0°C to 70°C, V_{CCI} = 3.3 V ± 5%, V_{CCO} = 3.3 V ± 5%)

Symbol	Characteristic		Condition	Min	Typ	Max	Unit
V _{IH}	Input HIGH Voltage	CMOS_CLK		2.4		V _{CCI}	V
V _{IL}	Input LOW Voltage	CMOS_CLK				0.8	V
V _{PP}	Peak-to-Peak Input Voltage	PECL_CLK		500		1000	mV
V _{CMR}	Common Mode Range	PECL_CLK		V _{CCI} - 1.4		V _{CCI} - 0.6	V
V _{OH}	Output HIGH Voltage		I _{OH} = -20 mA	2.4			V
V _{OL}	Output LOW Voltage		I _{OL} = 20 mA			0.5	V
I _{IN}	Input Current					± 200	µA
C _{IN}	Input Capacitance				4.0		pF
C _{pd}	Power Dissipation Capacitance		per output		10		pF
Z _{OUT}	Output Impedance			18	23	28	Ω
I _{CC}	Maximum Quiescent Supply Current				0.5	1.0	mA

ASM2I9940L

Table 6. AC CHARACTERISTICS ($T_A = 0^\circ\text{C}$ to 70°C , $V_{CCI} = 3.3\text{ V} \pm 5\%$, $V_{CCO} = 3.3\text{ V} \pm 5\%$)

Symbol	Characteristic		Condition	Min	Typ	Max	Unit
F_{\max}	Maximum Input Frequency					250	MHz
t_{PLH}	Propagation Delay	PECL_CLK \leq 150 MHz CMOS_CLK \leq 150 MHz	(Note 1)	2.0 1.7	2.7 2.5	3.4 3.0	nS
t_{PLH}	Propagation Delay	PECL_CLK $>$ 150 MHz CMOS_CLK $>$ 150 MHz		2.0 1.8	2.9 2.5	3.7 3.2	nS
$t_{sk(o)}$	Output-to-output Skew	PECL_CLK CMOS_CLK	(Note 1)			150 150	pS
$t_{sk(pp)}$	Part-to-Part Skew	PECL_CLK \leq 150 MHz CMOS_CLK \leq 150 MHz	(Notes 1 and 2)			1.5 1.3	nS
$t_{sk(pp)}$	Part-to-Part Skew	PECL_CLK $>$ 150 MHz CMOS_CLK $>$ 150 MHz	(Notes 1 and 2)			1.8 1.5	nS
$t_{sk(pp)}$	Part-to-Part Skew	PECL_CLK CMOS_CLK	(Notes 1 and 3)			850 750	pS
DC	Output Duty Cycle	$f_{CLK} <$ 134 MHz $f_{CLK} \leq$ 250 MHz	Input DC = 50% Input DC = 50%	45 40	50 50	55 60	%
t_r, t_f	Output Rise/Fall Time		0.5 – 2.4 V	0.3		1.1	nS

1. Tested using standard input levels, Production tested @ 150 MHz.
2. Across temperature and voltage ranges, includes output skew.
3. For a specific temperature and voltage, includes output skew.

Table 7. DC CHARACTERISTICS ($T_A = 0^\circ\text{C}$ to 70°C , $V_{CCI} = 3.3\text{ V} \pm 5\%$, $V_{CCO} = 2.5\text{ V} \pm 5\%$)

Symbol	Characteristic		Condition	Min	Typ	Max	Unit
V_{IH}	Input HIGH Voltage	CMOS_CLK		2.4		V_{CCI}	V
V_{IL}	Input LOW Voltage	CMOS_CLK				0.8	V
V_{PP}	Peak-to-Peak Input Voltage	PECL_CLK		500		1000	mV
V_{CMR}	Common Mode Range	PECL_CLK		$V_{CCI} - 1.4$		$V_{CCI} - 0.6$	V
V_{OH}	Output HIGH Voltage		$I_{OH} = -12\text{ mA}$	1.8			V
V_{OL}	Output LOW Voltage		$I_{OL} = 12\text{ mA}$			0.5	V
I_{IN}	Input Current					± 200	μA
C_{IN}	Input Capacitance				4.0		pF
C_{pd}	Power Dissipation Capacitance		per output		10		pF
Z_{OUT}	Output Impedance				23		Ω
I_{CC}	Maximum Quiescent Supply Current				0.5	1.0	mA

ASM2I9940L

Table 8. AC CHARACTERISTICS ($T_A = 0^\circ\text{C}$ to 70°C , $V_{CCI} = 3.3\text{ V} \pm 5\%$, $V_{CCO} = 2.5\text{ V} \pm 5\%$)

Symbol	Characteristic		Condition	Min	Typ	Max	Unit
F_{\max}	Maximum Input Frequency					250	MHz
t_{PLH}	Propagation Delay	PECL_CLK \leq 150 MHz CMOS_CLK \leq 150 MHz	(Note 4)	2.0 1.7	2.8 2.5	3.5 3.0	nS
t_{PLH}	Propagation Delay	PECL_CLK $>$ 150 MHz CMOS_CLK $>$ 150 MHz		2.0 1.8	2.9 2.5	3.8 3.3	nS
$t_{sk(o)}$	Output-to-output Skew	PECL_CLK CMOS_CLK	(Note 4)			150 150	pS
$t_{sk(pp)}$	Part-to-Part Skew	PECL_CLK \leq 150 MHz CMOS_CLK \leq 150 MHz	(Notes 4 and 5)			1.5 1.3	nS
$t_{sk(pp)}$	Part-to-Part Skew	PECL_CLK $>$ 150 MHz CMOS_CLK $>$ 150 MHz	(Notes 4 and 5)			1.8 1.5	nS
$t_{sk(pp)}$	Part-to-Part Skew	PECL_CLK CMOS_CLK	(Notes 4 and 6)			850 750	pS
DC	Output Duty Cycle	$f_{CLK} <$ 134 MHz $f_{CLK} \leq$ 250 MHz	Input DC = 50% Input DC = 50%	45 40	50 50	55 60	%
t_r, t_f	Output Rise/Fall Time		0.5 – 1.8 V	0.3		1.2	nS

4. Tested using standard input levels, Production tested @ 150 MHz.
5. Across temperature and voltage ranges, includes output skew.
6. For a specific temperature and voltage, includes output skew.

Table 9. DC CHARACTERISTICS ($T_A = 0^\circ\text{C}$ to 70°C , $V_{CCI} = 2.5\text{ V} \pm 5\%$, $V_{CCO} = 2.5\text{ V} \pm 5\%$)

Symbol	Characteristic		Condition	Min	Typ	Max	Unit
V_{IH}	Input HIGH Voltage	CMOS_CLK		2.0		V_{CCI}	V
V_{IL}	Input LOW Voltage	CMOS_CLK				0.8	V
V_{PP}	Peak-to-Peak Input Voltage	PECL_CLK		500		1000	mV
V_{CMR}	Common Mode Range	PECL_CLK		$V_{CCI} - 1.0$		$V_{CCI} - 0.6$	V
V_{OH}	Output HIGH Voltage		$I_{OH} = -12\text{ mA}$	1.8			V
V_{OL}	Output LOW Voltage		$I_{OL} = 12\text{ mA}$			0.5	V
I_{IN}	Input Current					± 200	μA
C_{IN}	Input Capacitance				4.0		pF
C_{pd}	Power Dissipation Capacitance		per output		10		pF
Z_{OUT}	Output Impedance			18	23	28	Ω
I_{CC}	Maximum Quiescent Supply Current				0.5	1.0	mA

ASM2I9940L

Table 10. AC Characteristics ($T_A = 0^\circ\text{C}$ to 70°C , $V_{CC1} = 2.5\text{ V} \pm 5\%$, $V_{CC0} = 2.5\text{ V} \pm 5\%$)

Symbol	Characteristic		Condition	Min	Typ	Max	Unit
F_{max}	Maximum Input Frequency					200	MHz
t_{PLH}	Propagation Delay	PECL_CLK \leq 150 MHz CMOS_CLK \leq 150 MHz	(Note 7)	2.6 2.3	4.0 3.1	5.2 4.0	nS
t_{PLH}	Propagation Delay	PECL_CLK $>$ 150 MHz CMOS_CLK $>$ 150 MHz		2.8 2.3	3.8 3.1	5.0 4.0	nS
$t_{\text{sk(o)}}$	Output-to-output Skew Within one bank	PECL_CLK CMOS_CLK	(Note 7)			200 200	pS
$t_{\text{sk(pp)}}$	Part-to-Part Skew	PECL_CLK \leq 150 MHz CMOS_CLK \leq 150 MHz	(Notes 7 and 8)			2.6 1.7	nS
$t_{\text{sk(pp)}}$	Part-to-Part Skew	PECL_CLK $>$ 150 MHz CMOS_CLK $>$ 150 MHz	(Notes 7 and 8)			2.2 1.7	nS
$t_{\text{sk(pp)}}$	Part-to-Part Skew	PECL_CLK CMOS_CLK	(Notes 7 and 9)			1.2 1.0	nS
DC	Output Duty Cycle	$f_{\text{CLK}} <$ 134 MHz $f_{\text{CLK}} \leq$ 200 MHz	Input DC = 50% Input DC = 50%	45 40	50 50	55 60	%
t_r, t_f	Output Rise/Fall Time		0.5 – 1.8 V	0.3		1.2	nS

7. Tested using standard input levels, Production tested @ 150 MHz.

8. Across temperature and voltage ranges, includes output skew.

9. For a specific temperature and voltage, includes output skew.

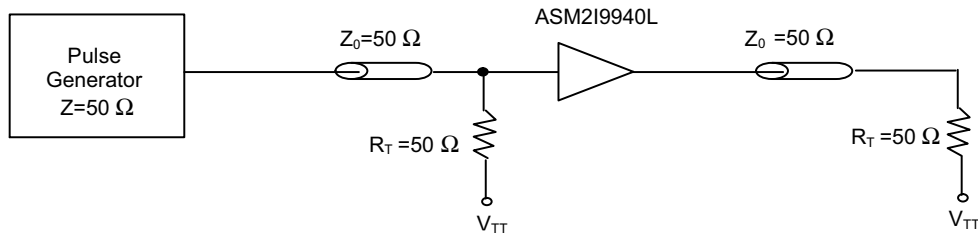

Figure 3. LVMOS_CLK ASM2I9940L AC Test Reference for $V_{CC} = 3.3\text{ V}$ and $V_{CC} = 2.5\text{ V}$

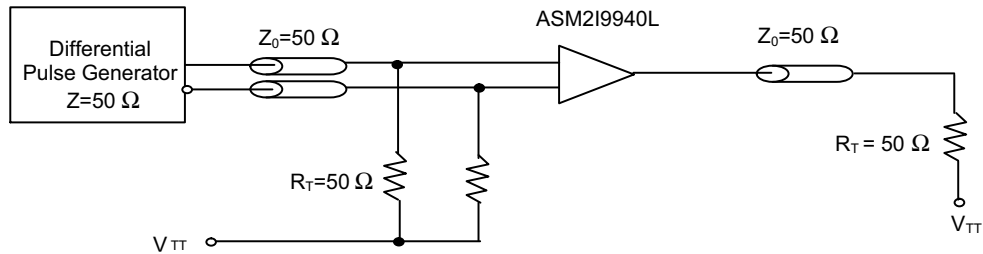

Figure 4. PECL_CLK ASM2I9940L AC Test Reference for $V_{CC} = 3.3\text{ V}$ and $V_{CC} = 2.5\text{ V}$

ASM2I9940L

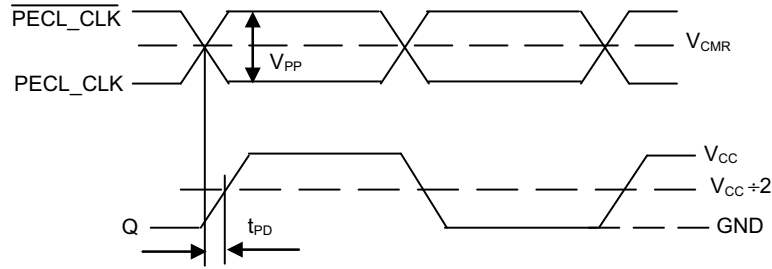

Figure 5. Propagation Delay (t_{PD}) Test Reference

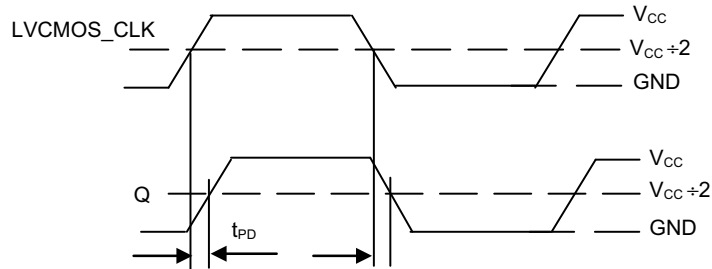
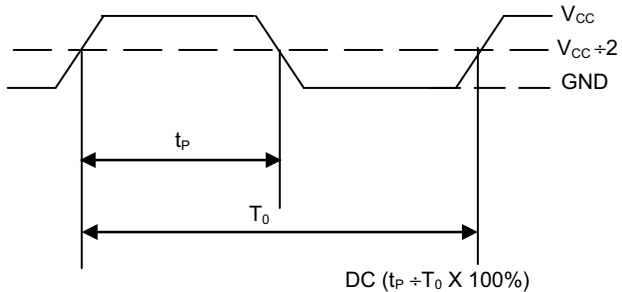
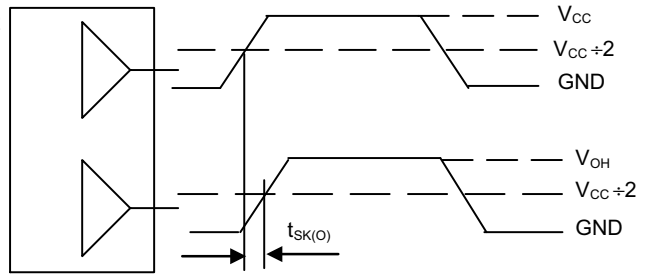

Figure 6. LVCMOS Propagation Delay (t_{PD}) Test Reference



The time from the PLL controlled edge to the non-controlled edge, divided by the time between PLL controlled edges, expressed as a percentage.

Figure 7. Output Duty Cycle (DC)



The pin-to-pin skew is defined as the worst case difference in propagation delay between any similar delay path within a single device

Figure 8. Output-to-Output Skew $t_{SK(O)}$

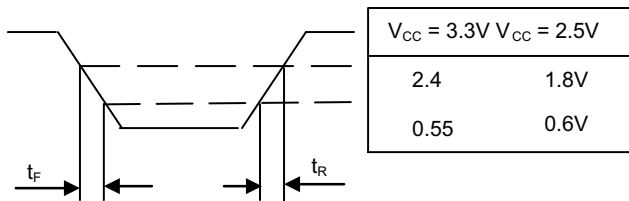

Figure 9. Output Transition Time Test Reference

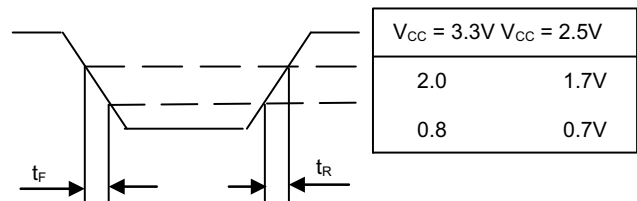

Figure 10. Input Transition Time Test Reference

Power Consumption of the ASM2I9940L and Thermal Management

The ASM2I9940L AC specification is guaranteed for the entire operating frequency range up to 250 MHz. The ASM2I9940L power consumption and the associated long-term reliability may decrease the maximum frequency limit, depending on operating conditions such as clock frequency, supply voltage, output loading, ambient temperature, vertical convection and thermal conductivity of package and board. This section describes the impact of these parameters on the junction temperature and gives a guideline to estimate the ASM2I9940L die junction temperature and the associated device reliability.

Table 11. DIE JUNCTION TEMPERATURE AND MTBF

Junction Temperature (°C)	MTBF (Years)
100	20.4
110	9.1
120	4.2
130	2.0

Increased power consumption will increase the die junction temperature and impact the device reliability (MTBF). According to the system-defined tolerable MTBF, the die junction temperature of the ASM2I9940L needs to be controlled and the thermal impedance of the board/package should be optimized. The power dissipated in the ASM2I9940L is represented in Equation 1.

$$P_{TOT} = \left[I_{CCQ} + V_{CC} \cdot f_{CLOCK} \cdot \left(N \cdot C_{PD} + \sum_M C_L \right) \right] \cdot V_{CC} \tag{eq. 1}$$

$$P_{TOT} = V_{CC} \cdot \left[I_{CCQ} + V_{CC} \cdot f_{CLOCK} \cdot \left(N \cdot C_{PD} + \sum_M C_L \right) \right] + \sum_P \left[DC_Q \cdot I_{OH}(V_{CC} - V_{OH}) + (1 - DC_Q) \cdot I_{OL} \cdot V_{OL} \right] \tag{eq. 2}$$

$$T_J = T_A + P_{TOT} \cdot R_{\theta JA} \tag{eq. 3}$$

$$f_{CLOCKMAX} = \frac{1}{C_{PD} \cdot N \cdot V_{CC}^2} \cdot \left[\frac{T_{JMAX} - T_A}{R_{\theta JA}} - (I_{CCQ} \cdot V_{CC}) \right] \tag{eq. 4}$$

T_{J,MAX} should be selected according to the MTBF system requirements and Table 11. R_{θja} can be derived from Table 12. The R_{θja} represent data based on 1S2P boards, using 2S2P boards will result in a lower thermal impedance than indicated below.

Where I_{CCQ} is the static current consumption of the ASM2I9940L, C_{PD} is the power dissipation capacitance per output, (M)ΣC_L represents the external capacitive output load, N is the number of active outputs (N is always 12 in case of the ASM2I9940L). The ASM2I9940L supports driving transmission lines to maintain high signal integrity and tight timing parameters. Any transmission line will hide the lumped capacitive load at the end of the board trace, therefore, ΣC_L is zero for controlled transmission line systems and can be eliminated from Equation 1. Using parallel termination output termination results in Equation 2 for power dissipation.

In Equation 2, P stands for the number of outputs with a parallel or thevenin termination, V_{OL}, I_{OL}, V_{OH} and I_{OH} are a function of the output termination technique and DC_Q is the clock signal duty cycle. If transmission lines are used ΣC_L is zero in Equation 2 and can be eliminated. In general, the use of controlled transmission line techniques eliminates the impact of the lumped capacitive loads at the end lines and greatly reduces the power dissipation of the device. Equation 3 describes the die junction temperature T_J as a function of the power consumption.

Where R_{θja} is the thermal impedance of the package (junction-to-ambient) and T_A is the ambient temperature. According to Table 11, the junction temperature can be used to estimate the long-term device reliability. Further, combining Equation 1 and Equation 2 results in a maximum operating frequency for the ASM2I9940L in a series terminated transmission line system, Equation 4.

Table 12. THERMAL PACKAGE IMPEDANCE OF THE 32LQFP

Convection, LFPM	R _{thja} (1P2S board), °C/W	R _{thja} (2P2S board), °C/W
Still air	86	61
100 lfpm	76	56
200 lfpm	71	54
300 lfpm	68	53
400 lfpm	66	52
500 lfpm	60	49

ASM2I9940L

If the calculated maximum frequency is below 250 MHz, it becomes the upper clock speed limit for the given application conditions. The following eight derating charts describe the safe frequency operation range for the ASM2I9940L. The charts were calculated for a maximum tolerable die junction temperature of 110°C (120°C),

corresponding to an estimated MTBF of 9.1 years (4 years), a supply voltage of 3.3 V and series terminated transmission line or capacitive loading. Depending on a given set of these operating conditions and the available device convection a decision on the maximum operating frequency can be made.

ORDERING INFORMATION

Part Number	Marking	Package	Temperature	Shipping [†]
ASM2I9940LG-32LT	2I9940L	32-pin LQFP Pb-Free	-40°C to +85°C	250 Units / Tray

ASM2I9940L

PACKAGE DIMENSIONS

32 LEAD LQFP
CASE 873A-02
ISSUE C

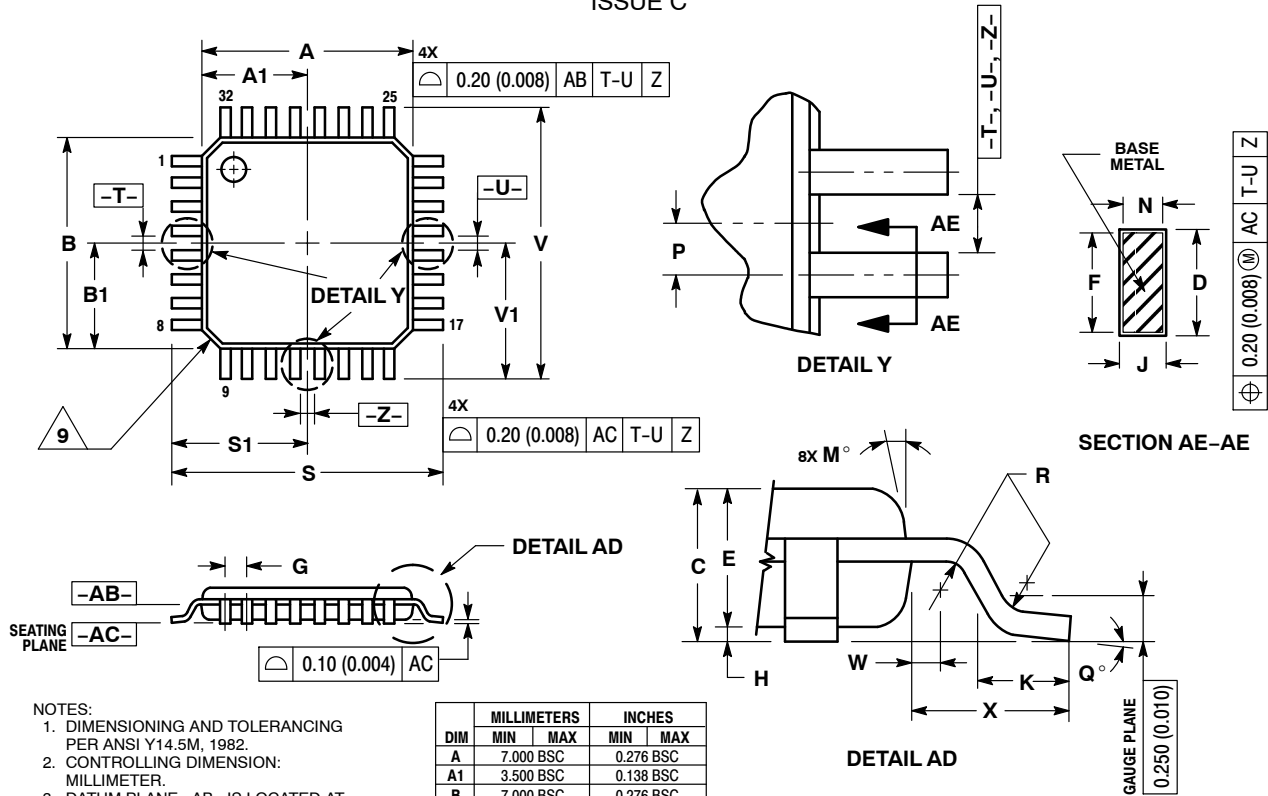

NOTES:

- DIMENSIONING AND TOLERANCING PER ANSI Y14.5M, 1982.
- CONTROLLING DIMENSION: MILLIMETER.
- DATUM PLANE -AB- IS LOCATED AT BOTTOM OF LEAD AND IS COINCIDENT WITH THE LEAD WHERE THE LEAD EXITS THE PLASTIC BODY AT THE BOTTOM OF THE PARTING LINE.
- DATUMS -T-, -U-, AND -Z- TO BE DETERMINED AT DATUM PLANE -AB-.
- DIMENSIONS S AND V TO BE DETERMINED AT SEATING PLANE -AC-.
- DIMENSIONS A AND B DO NOT INCLUDE MOLD PROTRUSION. ALLOWABLE PROTRUSION IS 0.250 (0.010) PER SIDE. DIMENSIONS A AND B DO INCLUDE MOLD MISMATCH AND ARE DETERMINED AT DATUM PLANE -AB-.
- DIMENSION D DOES NOT INCLUDE DAMBAR PROTRUSION. DAMBAR PROTRUSION SHALL NOT CAUSE THE D DIMENSION TO EXCEED 0.520 (0.020).
- MINIMUM SOLDER PLATE THICKNESS SHALL BE 0.0076 (0.0003).
- EXACT SHAPE OF EACH CORNER MAY VARY FROM DEPICTION.

Pentium is a registered trademark of Intel Corporation.

ON Semiconductor and are registered trademarks of Semiconductor Components Industries, LLC (SCILLC). SCILLC reserves the right to make changes without further notice to any products herein. SCILLC makes no warranty, representation or guarantee regarding the suitability of its products for any particular purpose, nor does SCILLC assume any liability arising out of the application or use of any product or circuit, and specifically disclaims any and all liability, including without limitation special, consequential or incidental damages. "Typical" parameters which may be provided in SCILLC data sheets and/or specifications can and do vary in different applications and actual performance may vary over time. All operating parameters, including "Typicals" must be validated for each customer application by customer's technical experts. SCILLC does not convey any license under its patent rights nor the rights of others. SCILLC products are not designed, intended, or authorized for use as components in systems intended for surgical implant into the body, or other applications intended to support or sustain life, or for any other application in which the failure of the SCILLC product could create a situation where personal injury or death may occur. Should Buyer purchase or use SCILLC products for any such unintended or unauthorized application, Buyer shall indemnify and hold SCILLC and its officers, employees, subsidiaries, affiliates, and distributors harmless against all claims, costs, damages, and expenses, and reasonable attorney fees arising out of, directly or indirectly, any claim of personal injury or death associated with such unintended or unauthorized use, even if such claim alleges that SCILLC was negligent regarding the design or manufacture of the part. SCILLC is an Equal Opportunity/Affirmative Action Employer. This literature is subject to all applicable copyright laws and is not for resale in any manner.

PUBLICATION ORDERING INFORMATION

LITERATURE FULFILLMENT:

Literature Distribution Center for ON Semiconductor
P.O. Box 5163, Denver, Colorado 80217 USA
Phone: 303-675-2175 or 800-344-3860 Toll Free USA/Canada
Fax: 303-675-2176 or 800-344-3867 Toll Free USA/Canada
Email: orderlit@onsemi.com

N. American Technical Support: 800-282-9855 Toll Free
USA/Canada
Europe, Middle East and Africa Technical Support:
Phone: 421 33 790 2910
Japan Customer Focus Center
Phone: 81-3-5773-3850

ON Semiconductor Website: www.onsemi.com
Order Literature: <http://www.onsemi.com/orderlit>
For additional information, please contact your local Sales Representative