

### Trench Gate Design Dual IGBTMOD™ 100 Amperes/600 Volts

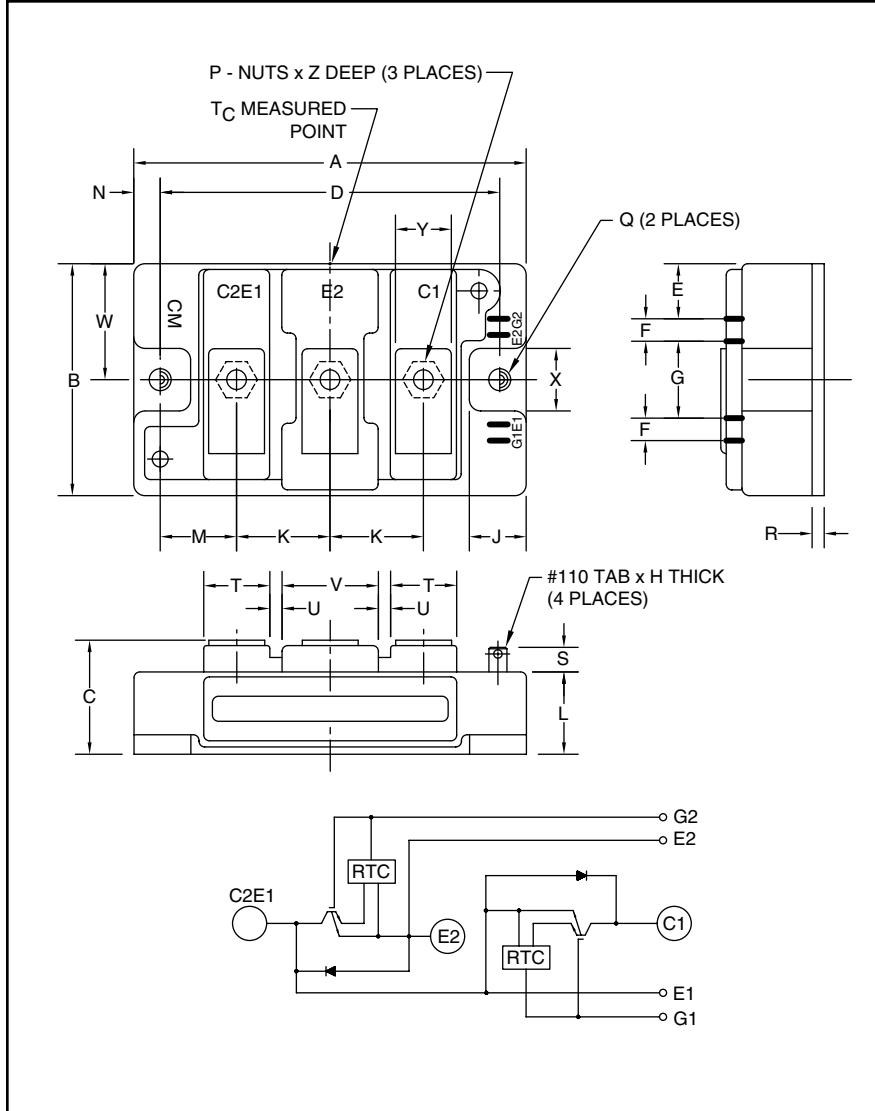

Outline Drawing and Circuit Diagram

Dimensions	Inches	Millimeters
A	3.70	94.0
B	1.89	48.0
C	1.18 +0.04/-0.02	30.0 +1.0/-0.5
D	3.15±0.01	80.0±0.25
E	0.43	11.0
F	0.16	4.0
G	0.71	18.0
H	0.02	0.5
J	0.53	13.5
K	0.91	23.0
L	0.83	21.2
M	0.67	17.0

Dimensions	Inches	Millimeters
N	0.28	7.0
P	M5	M5
Q	0.26 Dia.	6.5 Dia.
R	0.02	4.0
S	0.30	7.5
T	0.63	16.0
U	0.10	2.5
V	1.0	25.0
W	0.94	24.0
X	0.51	13.0
Y	0.47	12.0
Z	0.47	12.0



#### Description:

Powerex IGBTMOD™ Modules are designed for use in high frequency applications; 30 kHz for hard switching applications and 60 to 70 kHz for soft switching applications. Each module consists of two IGBT Transistors in a half-bridge configuration with each transistor having a reverse-connected super-fast recovery free-wheel diode. All components and interconnects are isolated from the heat sinking baseplate, offering simplified system assembly and thermal management.

#### Features:

- Low  $V_{CE(sat)}$
- Low  $E_{SW(off)}$
- Discrete Super-Fast Recovery Free-Wheel Diode
- Isolated Baseplate for Easy Heat Sinking

#### Applications:

- Power Supplies
- Induction Heating
- Welders

#### Ordering Information:

Example: Select the complete module number you desire from the table - i.e. CM100DUS-12F is a 600V ( $V_{CES}$ ), 100 Ampere Dual IGBTMOD™ Power Module.

Type	Current Rating Amperes	$V_{CES}$ Volts (x 50)
CM	100	12



Powerex, Inc., 200 E. Hillis Street, Youngwood, Pennsylvania 15697-1800 (724) 925-7272

**CM100DUS-12F**  
**Trench Gate Design Dual IGBTMOD™**  
 100 Amperes/600 Volts

**Absolute Maximum Ratings,  $T_j = 25^\circ\text{C}$  unless otherwise specified**

Ratings	Symbol	CM100DUS-12F	Units
Junction Temperature	$T_j$	-40 to 150	$^\circ\text{C}$
Storage Temperature	$T_{stg}$	-40 to 125	$^\circ\text{C}$
Collector-Emitter Voltage (G-E SHORT)	$V_{CES}$	600	Volts
Gate-Emitter Voltage (C-E SHORT)	$V_{GES}$	$\pm 20$	Volts
Collector Current ( $T_c = 25^\circ\text{C}$ )	$I_C$	100	Amperes
Peak Collector Current	$I_{CM}$	200*	Amperes
Emitter Current** ( $T_c = 25^\circ\text{C}$ )	$I_E$	100	Amperes
Peak Emitter Current**	$I_{EM}$	200*	Amperes
Maximum Collector Dissipation ( $T_c = 25^\circ\text{C}$ , $T_j \leq 150^\circ\text{C}$ )	$P_c$	350	Watts
Mounting Torque, M5 Main Terminal	–	31	in-lb
Mounting Torque, M6 Mounting	–	40	in-lb
Weight	–	310	Grams
Isolation Voltage (Main Terminal to Baseplate, AC 1 min.)	$V_{iso}$	2500	Volts

\* Pulse width and repetition rate should be such that the device junction temperature ( $T_j$ ) does not exceed  $T_{j(max)}$  rating.

\*\*Represents characteristics of the anti-parallel, emitter-to-collector free-wheel diode (FWDi).

**Static Electrical Characteristics,  $T_j = 25^\circ\text{C}$  unless otherwise specified**

Characteristics	Symbol	Test Conditions	Min.	Typ.	Max.	Units
Collector-Cutoff Current	$I_{CES}$	$V_{CE} = V_{CES}$ , $V_{GE} = 0V$	–	–	1	mA
Gate Leakage Current	$I_{GES}$	$V_{GE} = V_{GES}$ , $V_{CE} = 0V$	–	–	20	$\mu\text{A}$
Gate-Emitter Threshold Voltage	$V_{GE(th)}$	$I_C = 10\text{mA}$ , $V_{CE} = 10V$	5	6	7	Volts
Collector-Emitter Saturation Voltage	$V_{CE(sat)}$	$I_C = 100A$ , $V_{GE} = 15V$ , $T_j = 25^\circ\text{C}$	1.7	2.0	2.7	Volts
		$I_C = 100A$ , $V_{GE} = 15V$ , $T_j = 125^\circ\text{C}$	–	1.95	–	Volts
Total Gate Charge	$Q_G$	$V_{CC} = 300V$ , $I_C = 100A$ , $V_{GE} = 15V$	–	620	–	nC
Emitter-Collector Voltage**	$V_{EC}$	$I_E = 100A$ , $V_{GE} = 0V$	–	–	2.6	Volts

\*\*Represents characteristics of the anti-parallel, emitter-to-collector free-wheel diode (FWDi).

**Dynamic Electrical Characteristics,  $T_j = 25^\circ\text{C}$  unless otherwise specified**

Characteristics	Symbol	Test Conditions	Min.	Typ.	Max.	Units
Input Capacitance	$C_{ies}$		–	–	27	nf
Output Capacitance	$C_{oes}$	$V_{CE} = 10V$ , $V_{GE} = 0V$	–	–	1.8	nf
Reverse Transfer Capacitance	$C_{res}$		–	–	1	nf
Resistive	Turn-on Delay Time	$V_{CC} = 300V$ , $I_C = 100A$ , $V_{GE1} = V_{GE2} = 15V$ ,	–	–	100	ns
	Rise Time					
Load	Turn-off Delay Time	$R_G = 6.3\Omega$ , Inductive Load Switching Operation	–	–	300	ns
	Fall Time					
Diode Reverse Recovery Time**	$t_{rr}$	$I_E = 100A$	–	–	150	ns
Diode Reverse Recovery Charge**	$Q_{rr}$		–	1.9	–	$\mu\text{C}$

\*\*Represents characteristics of the anti-parallel, emitter-to-collector free-wheel diode (FWDi).



Powerex, Inc., 200 E. Hillis Street, Youngwood, Pennsylvania 15697-1800 (724) 925-7272

**CM100DUS-12F**  
**Trench Gate Design Dual IGBTMOD™**  
 100 Amperes/600 Volts

**Thermal and Mechanical Characteristics,  $T_j = 25^\circ\text{C}$  unless otherwise specified**

Characteristics	Symbol	Test Conditions	Min.	Typ.	Max.	Units
Thermal Resistance, Junction to Case	$R_{th(j-c)Q}$	Per IGBT 1/2 Module, $T_c$ Reference Point per Outline Drawing	–		0.35	$^\circ\text{C/W}$
Thermal Resistance, Junction to Case	$R_{th(j-c)D}$	Per FWDi 1/2 Module, $T_c$ Reference Point per Outline Drawing	–	–	0.70	$^\circ\text{C/W}$
Thermal Resistance, Junction to Case	$R_{th(j-c)Q}$	Per IGBT 1/2 Module, $T_c$ Reference Point Under Chip	–	0.23**	–	$^\circ\text{C/W}$
Contact Thermal Resistance	$R_{th(c-f)}$	Per Module, Thermal Grease Applied	–	0.07	–	$^\circ\text{C/W}$

\*\* If you use this value,  $R_{th(f-a)}$  should be measured just under the chips.

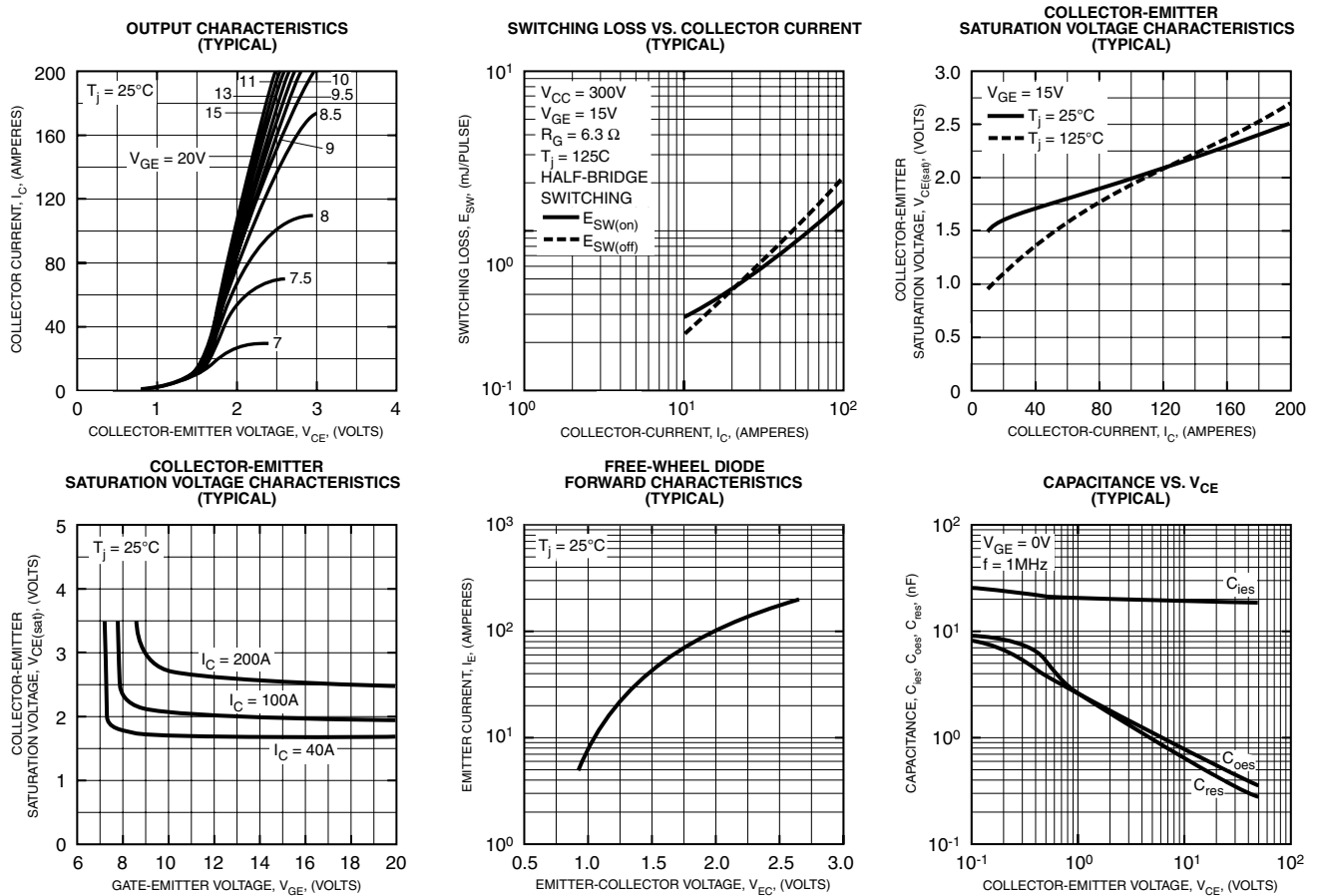



Powerex, Inc., 200 E. Hillis Street, Youngwood, Pennsylvania 15697-1800 (724) 925-7272

**CM100DUS-12F**  
**Trench Gate Design Dual IGBTMOD™**  
 100 Amperes/600 Volts

**HALF-BRIDGE SWITCHING CHARACTERISTICS (TYPICAL)**

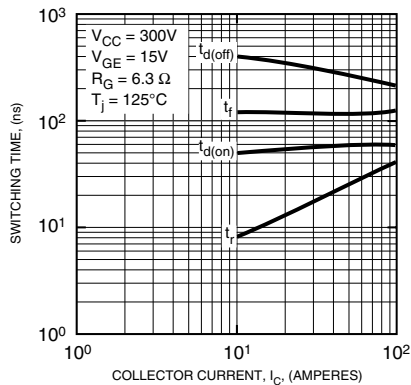

**REVERSE RECOVERY CHARACTERISTICS (TYPICAL)**

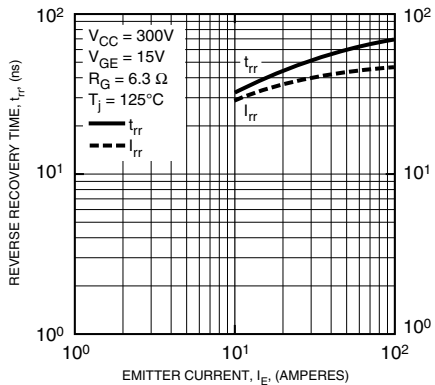

**GATE CHARGE,  $V_{GE}$**

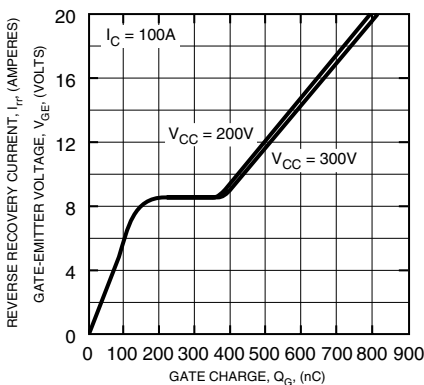

**REVERSE RECOVERY SWITCHING LOSS VS. EMITTER CURRENT (TYPICAL)**

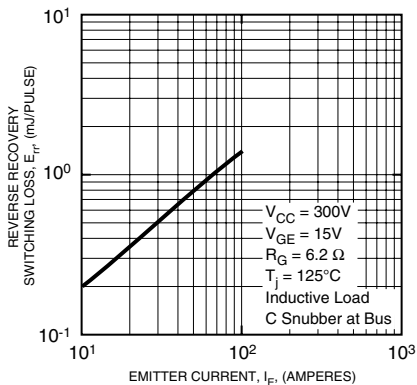

**REVERSE RECOVERY SWITCHING LOSS VS. GATE RESISTANCE (TYPICAL)**

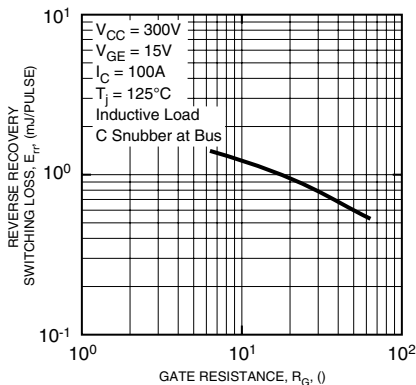

**TRANSIENT THERMAL IMPEDANCE CHARACTERISTICS (IGBT)**

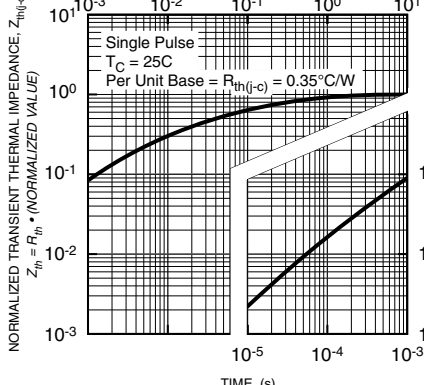

**TRANSIENT THERMAL IMPEDANCE CHARACTERISTICS (FWDI)**

